

# Crane Cables

General Catalogue



# Crane Cables

Special cables for cranes and material handling equipment

General catalogue

## Linking the Future

As the worldwide leader in the cable industry, Prysmian Group believes in the effective, efficient and sustainable supply of energy and information as a primary driver in the development of communities.

With this in mind, we provide major global organisations in many industries with best-in-class cable solutions, based on state-of-the-art technology. Through two renowned commercial brands - Prysmian and Draka - based in almost 50 countries, we're constantly close to our customers, enabling them to further develop the world's energy and telecoms infrastructures, and achieve sustainable, profitable growth.

In our energy business, we design, produce, distribute and install cables and systems for the transmission and distribution of power at low, medium, high and extra-high voltage.

In telecoms, the Group is a leading manufacturer of all types of copper and fibre cables, systems and accessories - covering voice, video and data transmission.

Drawing on over 130 years' experience and continuously investing in R&D, we apply excellence, understanding and integrity to everything we do, meeting and exceeding the precise needs of our customers across all continents, at the same time shaping the evolution of our industry.

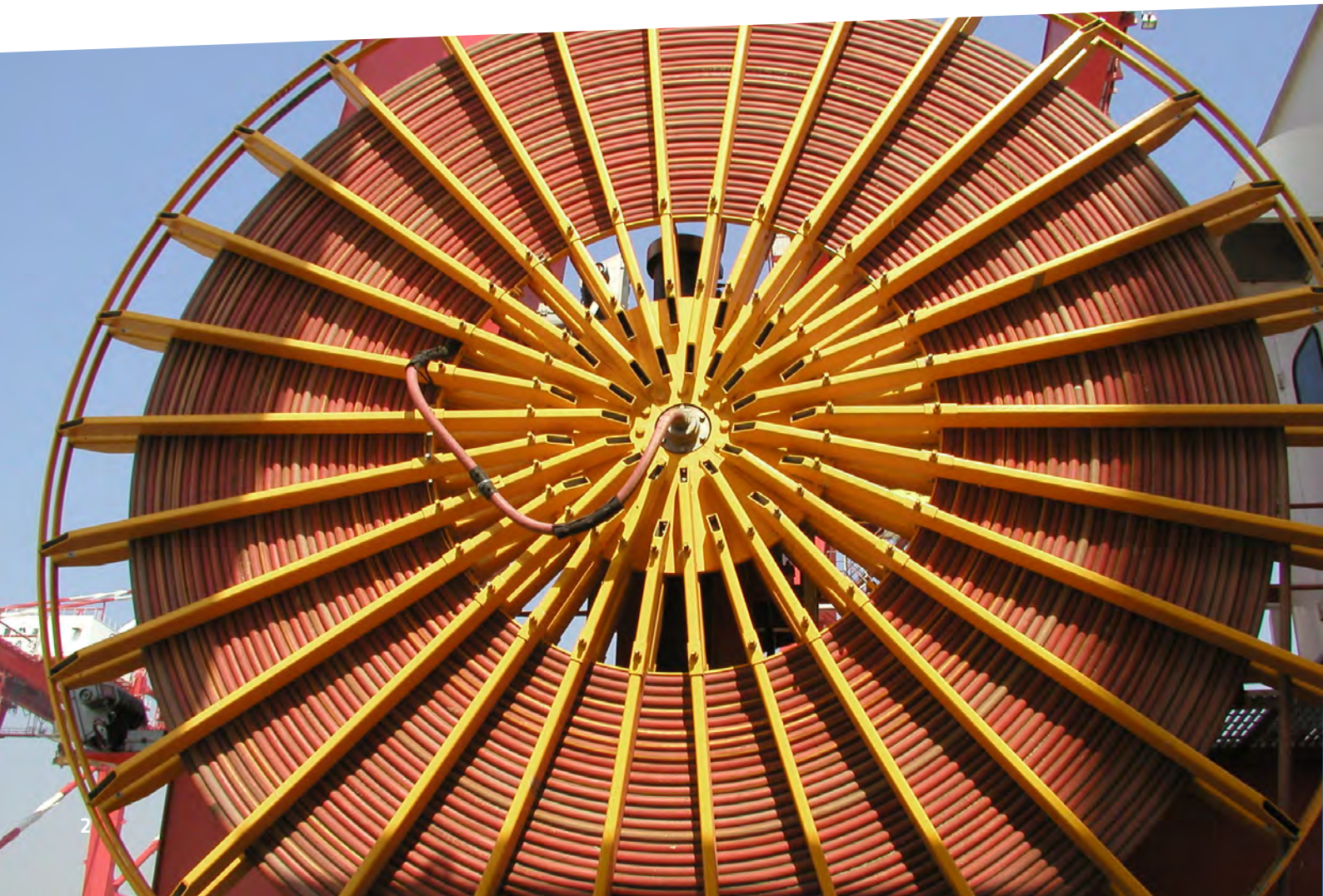



# What links global expertise to the wheels of industry?

High-performing cable solutions to keep the wheels of industry turning

On every continent, in the most demanding applications, our specialist cable solutions sit at the heart of significant international projects; supporting the work of major customers and the development of economies, with high-performing, durable and safe technology.

As the world leader in cabling, we draw on global expertise and local presence to work in close proximity with our customers, delivering products and service platforms built on easy contact, bespoke solutions and effective supply chain, meeting their specialised requirements, to help them drive the wheels of industry and achieve sustainable growth and profitability.



# Crane cables

## Introduction

The development of elastomeric power cables for safe and reliable crane and industrial applications has paralleled the development of the electric motor and power generation since the 19th century.

Elastomeric cables are the natural choice for applications where durability, flexibility, and safe operation under extreme environmental conditions are important. The Prysmian Group's elastomeric cables have been "field proven" in thousands of operations, and with continuous development, utilise the best features of cables offered around the world.

In Germany, as elsewhere, there are many established guidelines governing manufacture of crane and industrial cables. Innovation in work practices, with more equipment operating at higher voltages, has required the continued development of new elastomeric cable designs. Ongoing development programs have also been required to continually improve the reliability and safety of current designs. The major design responsibility for the Prysmian Group is to ensure that cables supplied will operate reliably and safely under a wide range of conditions. Personnel often work close to energised cables, therefore the cable construction and materials must be selected to provide maximum safety during both normal operation and in the case of cable failure.



## Application

Terminal operators require ever-increasing performance of machines and methods. This has led to the technologically advanced machines in use today. These special, movable equipments require medium voltage flexible reeling cables for power supply for instance, suitable for operation under the most extreme conditions.

Prysmian and Draka branded flexible reeling, festoon, basket and chain cables for cranes and material handling equipment have been field-proven worldwide for decades.

In these crane applications, particular requirements such as mechanical strength and safety have led to the use of high-grade mechanically resistant rubber.

Prysmian Group has developed extensive know-how over many years about the special operational conditions of cranes and material handling equipment. The decisive factor was close cooperation with many significant terminal operators and crane and reel manufacturers.

The experience we gain every day contributes to the design of our crane cables. The high operational reliability and service life of Prysmian's flexible reeling, festoon, basket and chain cables for cranes and material handling is based on this experience.



## Benefits

Prysmian Group's flexible electric cables for cranes and material handling equipment offer significant benefits to a broad variety of specialized industry professionals such as OEMs, specifiers, contractors, installers, terminal operators and more. These benefits include:

### **Unique Mechanical Performance**

Prysmian Group's crane cables have been designed to withstand extreme conditions in terms of:

- Tensile loads
- Torsional stresses occurring during misalignment of cable guidance systems and oblique pay out
- Minimum bending radius at any ambient temperature range and stress conditions
- High travel speeds and acceleration

### **Chemical and Climate Resistance**

Prysmian Group's crane cables have been designed to withstand the most severe conditions. For these applications Prysmian has developed the high performance compounds that are used in flexible electric cables for cranes and material handling equipment to guarantee resistance to extreme conditions and harsh environments (such as high-speed, abrasion, oil, moisture, extreme low/hot temperature, UV irradiation and ozone).



### **Miniaturised**

Prysmian Group's crane cables have the smallest possible dimensions. For instance, in MV cables:

- Dimension - up to 30% less and yet in strict compliance with the existing standards
- Weight - higher cable performance allow up to a 40% reduction in the cable weight
- Robustness - higher physical/mechanical resistance, exceeding standard requirements in terms of abrasion, cut-through and repeated bending

### **Customised and Multifunctional Engineering**

Prysmian designs and manufactures cables according to specific customer needs. This allows us to have an exhaustive product range covering all functionalities (MV/LV, Instrumentation and Control, Optical fibres). Prysmian designs multifunctional cables from the simplest to the most sophisticated.

### **Longer Lifetime**

Prysmian Group's crane cables guarantee an extended working lifetime (lower failure rate) in comparison with standard and traditional flexible electric cables for cranes and material handling equipment. As a consequence the total cost of ownership is lower.



# Crane cables

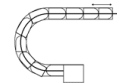

Chain

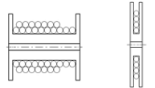

Reeling



Reeling

Festoon

Basket

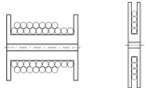

## Application Groups



### Low voltage reeling cables

CORDAFLEX (SMK)  
TROMMELFLEX PUR HF  
TROMMELFLEX (K)  
EASYFLEX

Cylindrical Reels	Mono Spiral Reels	Festoon system
+	+	+
+	+	+
+	+	
+		

### Low voltage reeling cables for E-RTGs

CORDAFLEX (SMK)  
TROMMELFLEX KSM-S

Cylindrical Reels	Mono Spiral Reels	Festoon system
+	+	+
+	+	

### Low voltage cables for vertical reeling

CORDAFLEX (SMK)-V  
SPREADER REEL PUR HF

Cylindrical Reels	Mono Spiral Reels
+	+
+	+

### Low voltage cables for basket operation

SPREADERFLEX

+

### Round low voltage cables for festoon operation

RONDOFLEX  
RONDOFLEX (C)-FC  
FESTOONFLEX PUR HF  
FESTOONFLEX C PUR HF

Cylindrical Reels	Mono Spiral Reels	Festoon system	Chain
+	+	+	
		+	
+	+	+	+
		+	+

### Flat low voltage cables for festoon operation

PLANOFLEX  
M(StD)HOEU Screened elements

+

### Low voltage cables for chain operation

RONDOFLEX (CHAIN)  
FESTOONFLEX PUR HF  
FESTOONFLEX C PUR HF

Cylindrical Reels	Mono Spiral Reels	Festoon system	Chain
			+
+	+	+	+
+	+	+	+

### Cables for data transmission

OPTOFLEX

Cylindrical Reels	Mono Spiral Reels	Festoon system
+	+	+

### Round medium voltage reeling cables

PROTOLON (SMK)  
PROTOLON (SMK) LWL  
TENAX-TTS  
TENAX TTS LWL

Cylindrical Reels	Mono Spiral Reels	Festoon system
+	+	+
+	+	+
+	+	+
+	+	+

### Flat medium voltage reeling cables

PROTOLON (FL)  
PROTOLON (FL) LWL

Mono Spiral Reels
+
+

+ main application

+ suitable

# Crane cables



# Index

## Product Datasheets

<b>Low voltage reeling cables</b>	page 15
CORDAFLEX(SMK) (N)SHTOEU	page 16
TROMMELFLEX PUR-HF D12Y11YU11Y	page 20
TROMMELFLEX (K) NSHTOEU	page 22
EASYFLEX (N)7YRDGOEU	page 24
<b>Low voltage reeling cables for E-RTGs</b>	page 27
CORDAFLEX(SMK) (N)SHTOEU	page 28
TROMMELFLEX (KSM-S) (N)SHTOEU	page 32
<b>Low voltage cables for vertical reeling</b>	page 37
CORDAFLEX(SMK)-V (N)SHTOEU	page 38
SPREADER REEL PUR-HF D12YST11YU11Y	page 40
<b>Low voltage cables for basket operation</b>	page 43
SPREADERFLEX 3GSLTOE	page 44
<b>Round low voltage cables for festoon operation</b>	page 49
RONDOFLEX (N)GRDGOEU	page 50
RONDOFLEX(C)-FC (N)GRDGCGOEU	page 54
FESTOONFLEX PUR-HF D12Y11Y	page 56
FESTOONFLEX C-PUR-HF D12YC11Y	page 60
<b>Flat low voltage cables for festoon operation</b>	page 65
PLANOFLEX NGFLGOEU	page 66
M(StD)HOEU	page 70
<b>Low voltage cables for chain operation</b>	page 73
RONDOFLEX(CHAIN) (N)GRDGOEU/(N)GRDGCGOEU	page 74
FESTOONFLEX PUR-HF D12Y11Y	page 78
FESTOONFLEX C-PUR-HF D12YC11Y	page 82
<b>Cables for data transmission</b>	page 87
OPTOFLEX G62.5/125, G50/125, E9/125	page 88
<b>Round medium voltage reeling cables</b>	page 91
PROTOLON(SMK) (N)TSCGEWOEU	page 92
PROTOLON(SMK)-LWL (N)TSKCGEWOEU	page 96
TENAX TTS (N)TSCGEWOEU	page 100
TENAX TTS-LWL (N)TSCGEWOEU	page 104

# Crane cables

## Product Datasheets

Flat medium voltage reeling cables	page 109
PROTOLON(FL) (N)TSFLCGEWOEU	page 110
PROTOLON(FL)-LWL (N)TSFLCGEWOEU	page 114

## Technical Annex

Application	page 119
Type / Trademark	page 119
Type / Type designation	page 120
Approvals / Standards	page 122
Installation of reeling cables	page 124
Centre feeding point	page 125
Electrical parameters	page 126
Thermal parameters	page 137
Mechanical parameters	page 139
Chemical parameters	page 146
Conductors	page 148
Compounds	page 152
Shield	page 154
Electrical field control with cables	page 155
Core arrangement	page 156
Colour coding of fibre-optics	page 158
Support elements	page 160
Anti-torsion braid	page 161
Cable Drum Overview	page 161
Comparison	page 162



# Crane cables



# LOW VOLTAGE REELING CABLES

	<b>CORDAFLEX (SMK)</b>	<b>TROMMELFLEX PUR HF</b>	<b>TROMMELFLEX (K)</b>	<b>EASYFLEX</b>
Designation	(N)SHTOEU	D12Y11YU11Y	NSHTOEU	(N)7YRDGOEU
Dimension	Based on DIN VDE 0250 part 814	Optimized	Acc. to DIN VDE 0250 part 814	Optimized
Cores	Power: 3C+3G, 4C, 5C Control: multicores	Power: 4C, 5C Control: multicores	Power: 3C+3G, 4C, 5C Control: multicores	Power: 4C, 5C Control: multicores
Outer Sheath	Rubber	PUR	Rubber	EVA
Approvals	VDE Reg. GOST-R			
Tensile Load	30 N/mm <sup>2</sup>	25 N/mm <sup>2</sup>	15 N/mm <sup>2</sup>	15 N/mm <sup>2</sup>
Speed	240 m/min	180 m/min	120 m/min	80 m/min
Temp. (moving)	-35°C/+80°C (special to -45°C on request)	-40°C/+80°C	-25°C/+80°C	-35°/+80°C



## CORDAFLEX(SMK) (N)SHTOEU Low voltage reeling cable



### Application

Flexible low voltage reeling cable for application under high and very high mechanical stresses.

### Global data

Brand	CORDAFLEX(SMK)
Type designation	(N)SHTOEU-J/-O
Standard	Based on DIN VDE 0250-814
Certifications / Approvals	VDE Reg. Nr. 7519; GOST-R

### Design features

Conductor	Electrolytic copper tinned, very finely stranded class FS
Insulation	PROTOLON MS Special compound based on high-quality EPR (min. 3GI3); improved mechanical and electrical characteristics.
Core identification	Best identification as a result of light colored insulation with numbers printed in black for power and control cables, earth conductor green-yellow colored.
Individual screen	Braid screen made of tinned copper wires. Transfer impedance optimized at 30 MHz. Surface covered: at least 60 % for shielded cores; at least 80 % for twisted and shielded pairs.
Core arrangement	Laid-up in a maximum of 3 layers
Sheath system	- PROTOFIRM Special - Inner sheath: High grade special compound based on PCP, color: yellow; - Anti-torsion braid: Reinforced braid made of polyester threads, in a vulcanized bond between the sheaths, resulting in a high strength of the sheath system; - PROTOFIRM Special - Outer sheath: A sheath system with a unique combination of flexibility and robustness has been achieved through the use of this structure. Abrasion and tear resistant special rubber compound based on PCP, color: yellow.
Marking	CORDAFLEX (SMK) (N)SHTOEU -J/-O (number of cores) x (cross section)+VDE Reg.-Nr.

### Electrical parameters

Rated voltage	0.6/1 kV (600/1000V)
Max. permissible operating voltage AC	0.7/1.2 kV
Max. permissible operating voltage DC	0.9/1.8 kV
AC Test Voltage	3.5 kV (5 Min.)
Data transmission	With special elements: ASI-Bus, Profibus, CAN-Bus, Industrial Ethernet. Alternatively: Fibre optics for transmitting all bus protocols.
Current Carrying Capacity description	Acc. to DIN VDE 0298-4

### Chemical parameters

Resistance to oil	Acc. to DIN EN 60811-404; DIN VDE 0473-811-404, paragraph 10
Weather resistance	Unrestricted use outdoors and indoors, resistant to ozone, UV and moisture.
Water resistance	Given and verified in long-term tests

### Thermal parameters

Max. permissible temperature at conductor	90 °C
Max. short circuit temperature of the conductor	250 °C
Ambient temperature for fixed installation	min -50 °C ; max +80 °C
Ambient temperature in fully flexible operation	min -35 °C ; max +80 °C

### Mechanical parameters

Max. tensile load on the conductor	30 N/mm <sup>2</sup>
Torsional stress	± 50 °/m
Min. bending radius	Acc. to DIN VDE 0298 part 3
Min. distance with S-type directional changes	20 X D
Travel speed	- Gantry (reeling operation): no restriction. It is recommended to consult the manufacturer for speeds beyond 240m/min; - Trolley (festoon operation): up to 240 m/min.
Additional tests	Reversed bending test, roller bending test, torsional stress test.

Number of cores x cross section	Part number	MLFB Number	Conductor diameter max. mm	Outer diameter min. mm	Outer diameter max. mm	Bending radius free moving min. mm	Weight (ca.) kg/km	Permissible tensile force max. N	Conductor resistance at 20°C max. Ω/km	Current carrying capacity (1) A	Short Circuit Current (conductor) kA
(N)SHTOEU-J power cables, 3-core design, earth conductor split in three											
3x35+3x16/3	20004037	5DH3121	8.4	28.7	31.7	159	1990	3150	0.57	162	5.01
3x50+3x25/3	20004038	5DH3122	10.3	34.4	37.4	187	2810	4500	0.39	202	7.15
3x70+3x35/3	20004039	5DH3123	12	39.7	42.7	214	3860	6300	0.28	250	10.01
3x95+3x50/3	20004040	5DH3124	14	44.3	47.3	237	4950	8550	0.21	301	13.59
3x120+3x70/3	20004041	5DH3125	15.8	51	55	275	6440	10800	0.16	352	17.16
3x150+3x70/3	20004042	5DH3126	17.5	53.9	57.9	290	7500	13500	0.13	404	21.45
3x185+3x95/3	20004043	5DH3127	19.4	58.9	62.9	315	8990	16650	0.11	461	26.46
3x240+3x120/3	20004044	5DH3128	22.5	67.4	71.4	357	11940	21600	0.08	540	34.32
3x300+3x150/3	20051390	5DH3119	25.2	75.6	79.6	398	14740	27000	0.07	620	42.9
(N)SHTOEU-J power cables, 4-core design											
4x4	20004047	5DH3132	3	16	18	90	450	480	5.09	41	0.57
4x6	20004048	5DH3133	3.6	17.4	19.4	97	600	720	3.39	53	0.86
4x10	20004049	5DH3134	4.6	21.6	23.6	118	900	1200	1.95	74	1.43
4x16	20004050	5DH3135	5.6	23.7	26.7	134	1240	1920	1.24	99	2.29
4x25	20004051	5DH3136	7.3	28.5	31.5	158	1850	3000	0.8	131	3.58
(N)SHTOEU-J power cables, 5-core design											
5x4	20014479	5DH3151	3	17.4	19.4	97	550	600	5.09	41	0.57
5x6	20004056	5DH3152	3.6	19	21	105	690	900	3.39	53	0.86
5x10	20004057	5DH3153	4.6	23.4	25.4	127	1070	1500	1.95	74	1.43
5x16	20004058	5DH3154	5.6	26.1	29.1	146	1500	2400	1.24	99	2.29
5x25	20004059	5DH3155	7.3	33.7	36.7	184	2340	3750	0.8	131	3.58
(N)SHTOEU-J control cables											
3x1,5	20007588	5DH3129	1.6	11.7	13.3	67	210	130	13.7	23	0.21
4x1,5	20004045	5DH3130	1.6	12.2	13.8	69	240	180	13.7	23	0.21
5x1,5	20004052	5DH3140	1.6	13	14.6	73	280	220	13.7	23	0.21
7x1,5	20004054	5DH3142	1.6	15.2	17.2	86	390	310	13.7	23	0.21
12x1,5	20004061	5DH3161	1.6	21.4	23.4	117	720	540	13.7	23	0.21
18x1,5	20004062	5DH3162	1.6	21.3	23.3	117	770	810	13.7	23	0.21
24x1,5	20004063	5DH3163	1.6	23.8	26.8	134	1020	1080	13.7	23	0.21
30x1,5	20135223	5DH3164	1.6	26.5	29.5	148	1240	1350	13.7	23	0.21
36x1,5	20024745	5DH3165	1.6	26.5	29.5	148	1290	1620	13.7	23	0.21
44x1,5		5DH3166	1.6	29.5	32.5	163	1530	1980	13.7	23	0.21
56x1,5	20054721	5DH3167	1.6	35.9	38.9	195	2040	2520	13.7	23	0.21
3x2,5	20004036	5DH3111	2	12.7	14.3	72	270	220	8.21	30	0.36
4x2,5	20004046	5DH3131	2	13.2	14.8	74	300	300	8.21	30	0.36
5x2,5	20004053	5DH3141	2	14.2	15.8	79	350	370	8.21	30	0.36
7x2,5	20004055	5DH3143	2	16.6	18.6	93	500	520	8.21	30	0.36
12x2,5	20004064	5DH3171	2	23.4	25.4	127	910	900	8.21	30	0.36
18x2,5	20004065	5DH3172	2	23.3	25.3	127	1010	1350	8.21	30	0.36
24x2,5	20004066	5DH3173	2	26.2	29.2	146	1340	1800	8.21	30	0.36
30x2,5	20004067	5DH3174	2	29.4	32.4	162	1660	2250	8.21	30	0.36

Number of cores x cross section	Part number	MLFB Number	Conductor diameter max. mm	Outer diameter min. mm	Outer diameter max. mm	Bending radius free moving min. mm	Weight (ca.) kg/km	Permissible tensile force max. N	Conductor resistance at 20°C max. Ω/km	Current carrying capacity (1) A	Short Circuit Current (conductor) kA
36x2,5	20004068	5DH3175	2	30.3	33.3	167	1750	2700	8.21	30	0.36
44x2,5	20004069	5DH3176	2	34.1	37.1	186	2180	3300	8.21	30	0.36
56x2,5	20004070	5DH3177	2	40.1	43.1	216	2870	4200	8.21	30	0.36
(N)SHTOEU-O bus cables											
6x(2x0,5)C		5DH3187	0.9	23.1	25.1	126	885	180	40.1	10	0.07
3x(2x1)C	20004074	5DH3186	1.3	22	24	120	730	180	20	18	0.14
6x(2x1)C	20004075	5DH3188	1.3	28.9	31.9	160	1300	360	20	18	0.14
9x(2x1)C	20004076	5DH3189	1.3	39.3	42.3	212	2150	540	20	18	0.14
12x(2x1)C		5DH3206	1.3	38.9	40.9	205	2170	720	20	18	0.14
12x1(C)	20007925	5DH3183	1.3	22.9	25.9	130	880	360	20	18	0.14
(N)SHTOEU-J combined control cables											
12x2,5+12x1(C)	20004073	5DH3184	2	27.2	30.2	151	1280	900	8.21	30	0.36
19x2,5+5x1(C)	20004071	5DH3180	2	26.2	29.2	146	1310	1420	8.21	30	0.36
19x2,5+5x1,5(C)	20037707	5DH3222	2	31	34	170	1580	1420	8.21	30	0.36
25x2,5+5x1(C)	20004072	5DH3181	2	29.4	32.4	162	1640	1870	8.21	30	0.36
(N)SHTOEU-J control cables with FO											
24x1,5+6x(2G62,5)	20040297	5DH3257	1.6	26.6	29.6	148	1180	1080	13.7	23	0.21
24x1,5+6x(2G50)	20025841	5DH3255	1.6	26.6	29.6	148	1180	1080	13.7	23	0.21
24x1,5+12x(2xE9)	20025742	5DH3254	1.6	26.5	29.5	148	1200	1080	13.7	23	0.21
20x2,5+6x(3G62,5)	20070669	5DH3170	2	28.4	31.4	157	1280	1500	8.21	30	0.36
20x2,5+6x(3E9)	20004087	5DH3234	2	28.4	31.4	157	1290	1500	8.21	30	0.36
24x2,5+6x(2E9)	20040470	5DH3194	2	29.4	32.4	162	1520	1800	8.21	30	0.36
28x2,5+2x(3G50)	20009380	5DH3249	2	29.4	32.4	162	1590	2100	8.21	30	0.36
30x2,5+6x(3E9)	20154112	5DH3169	2	30.2	33.3	167	1640	2250	8.21	30	0.36

(1) Nominal current carrying capacity for rubber cables laid on a surface, at 30°C ambient temperature (see also VDE 0298-4, Table 15). Special designs upon request!

## NOTES

---

---

---

---

---

---

---

---

---

---

---

---

---

---

---

---

---

---

---

---

---

---

---

---

---

---

---

---

---

---

## TROMMELFLEX PUR-HF D12Y11YU11Y

Low voltage reeling cable PUR sheathed



### Application

Flexible low voltage reeling cable for application under high mechanical stresses.

### Global data

Brand	TROMMELFLEX PUR-HF
Type designation	D12Y11YU11Y-J/O

### Design features

Conductor	Plain copper, flexible class 5 acc. to DIN EN 60228 / DIN VDE 0295
Insulation	Halogen free compound, based on polyester
Core identification	Up to 5 cores: colored in accordance with DIN VDE 0293-308 From 6 cores: natural color with black numbers
Core arrangement	Central textile carrier unit; cores twisted with short length of lay
Inner sheath	Polyurethan, halogen free, flame retardant
Reinforcement	Open braiding of support
Outer sheath	Polyurethane, halogen free, flame retardant, opaque; Colour: black
Marking	White imprint: TROMMELFLEX PUR-HF -J/-O (number of cores) x (cross-section) (week/year)

### Electrical parameters

Rated voltage	0.6/1 kV (600/1000V)
Max. permissible operating voltage AC	0.7/1.2 kV
Max. permissible operating voltage DC	0.9/1.8 kV
AC Test Voltage	4 kV (5 Min.)
Current Carrying Capacity description	Acc. to DIN VDE 0298-4

### Chemical parameters

Resistance to fire	Similar to IEC 60332-1
Water resistance	The cables are suitable for permanent use in water (no drinking water) up to 50 meter diving depth.

### Thermal parameters

Max. permissible temperature at conductor	90 °C
Max. short circuit temperature of the conductor	250 °C
Ambient temperature for fixed installation	min -50 °C ; max +80 °C
Ambient temperature in fully flexible operation	min -40 °C ; max +80 °C

### Mechanical parameters

Max. tensile load on the conductor	25 N/mm <sup>2</sup>
Torsional stress	± 50 °/m
Min. bending radius	6 x D (Proved by flexing tests acc. to HD 22.2 part 3.1)
Travel speed	- Reeling operation: no restriction (for speed beyond 180 m/min please consult the manufacturer); - Festoon system: up to 180 m/min.

Number of cores x cross section	Part number	Conductor diameter max. mm	Outer diameter min. mm	Outer diameter max. mm	Bending radius free moving min. mm	Weight (ca.) kg/km	Permissible tensile force max. N	Conductor resistance at 20°C max. Ω/km	Current carrying capacity (1) A	Short Circuit Current (conductor) kA
D12Y11YU11Y-J Control cables										
7x1,5		1.5	12	13.2	79	230	260	13.3	23	0.21
12x1,5		1.5	15.5	16.7	100	360	450	13.3	23	0.21
18x1,5	20165499	1.5	16.9	18.1	109	470	670	13.3	23	0.21
24x1,5		1.5	19	20.2	121	600	900	13.3	23	0.21
30x1,5		1.5	21.1	22.5	135	750	1120	13.3	23	0.21
7x2,5		2	13.5	14.7	88	310	430	7.98	30	0.36
12x2,5		2	18.9	20.1	121	550	750	7.98	30	0.36
18x2,5		2	19.2	20.4	122	670	1120	7.98	30	0.36
24x2,5	20160534	2	21.5	22.9	137	870	1500	7.98	30	0.36
30x2,5		2	24.4	26	156	1090	1870	7.98	30	0.36
36x2,5	20140743	2	27.4	29	174	1410	2250	7.98	30	0.36
D12Y11YU11Y-J power cables, four core design										
4x1,5		1.5	10	11.2	67	150	150	13.3	23	0.21
4x2,5		2	11.1	12.2	74	200	250	7.98	30	0.36
4x4		2.5	12.3	13.5	81	280	400	4.95	41	0.57
4x6	20161503	3.1	14.1	15.2	92	370	600	3.3	53	0.86
4x10		4.1	17.4	18.6	112	600	1000	1.91	74	1.43
4x16		5.1	20	21.4	128	850	1600	1.21	99	2.29
4x25	20149378	6.2	23.5	24.9	149	1230	2500	0.78	131	3.58
4x35	20156715	7.8	28.5	30.2	181	1760	3500	0.55	162	5.01
D12Y11YU11Y-J power cables, five core design										
5x1,5		1.5	10.6	11.7	71	170	180	13.3	23	0.21
5x2,5		2	11.8	13	78	230	310	7.98	30	0.36
5x4		2.5	13.3	14.5	87	330	500	4.95	41	0.57
5x6		3.1	16.4	17.6	106	480	750	3.3	53	0.86
5x10		4.1	18.7	19.9	119	720	1250	1.91	74	1.43
5x16		5.1	21.7	23.0	139	1030	2000	1.21	99	2.29
5x25		6.2	28.2	29.8	179	1500	3120	0.78	131	3.58
5x35		7.8	31	33	198	2140	4370	0.55	162	5.01

(1) Nominal current carrying capacity for rubber cables laid on a surface, at 30°C ambient temperature (see also VDE 0298-4, Table 15). For articles without part number the values shown are approximate, and need to be confirmed in case of order.

## TROMMELFLEX (K) NSHTOEU

Low voltage reeling cable



### Application

Flexible low voltage reeling cable for application under medium mechanical stresses.

### Global data

Brand	TROMMELFLEX (K)
Type designation	NSHTOEU
Standard	DIN VDE 0250-814

### Design features

Conductor	Tinned copper, flexible class 5 acc. to DIN EN 60228 / DIN VDE 0295
Insulation	Rubber compound type 3GI3 acc. to DIN VDE 0207-20
Core identification	Up to 5 cores: colored in accordance with DIN VDE 0293-308 From 6 cores: black with white numbers
Core arrangement	Central filler, plastic or textile, if necessary covered with rubber. Cores twisted at short length of lay
Inner sheath	Rubber compound type 5GM3 acc. to DIN VDE 0207-21
Reinforcement	Wide-meshed polyester braid, embedded in the sheath
Outer sheath	Extruded rubber compound type 5GM5 acc. to DIN VDE 0207-21. Abrasion and tear resistant, oil and flame resistant; Colour: black
Marking	White imprint: NSHTOEU-J (number of cores) x (cross-section) TROMMELFLEX(K) (meter marking)

### Electrical parameters

Rated voltage	0.6/1 kV (600/1000V)
Max. permissible operating voltage AC	0.7/1.2 kV
Max. permissible operating voltage DC	0.9/1.8 kV
AC Test Voltage	2.5 kV (5 Min.)
Current Carrying Capacity description	Acc. to DIN VDE 0298-4

### Chemical parameters

Resistance to fire	Acc. to IEC 60332-1 (EN 50265-2-1)
Resistance to oil	Acc. to EN 60811-404 - ASTM No. 2: 24h at 100 °C

### Thermal parameters

Max. permissible temperature at conductor	90 °C
Max. short circuit temperature of the conductor	250 °C
Ambient temperature for fixed installation	min -40 °C ; max +80 °C
Ambient temperature in fully flexible operation	min -25 °C ; max +80 °C

### Mechanical parameters

Max. tensile load on the conductor	15 N/mm <sup>2</sup>
Torsional stress	± 50 °/m
Min. bending radius	Acc. to DIN VDE 0298 part 3
Travel speed	- Reeling operation: up to 120 m/min

Number of cores x cross section	Part number	Conductor diameter max. mm	Outer diameter min. mm	Outer diameter max. mm	Bending radius free moving min. mm	Weight (ca.) kg/km	Permissible tensile force max. N	Conductor resistance at 20°C max. Ω/km	Current carrying capacity (1) A	Short Circuit Current (conductor) kA
NSHTOEU-J Control cables										
7x1,5		1.5	16.2	17.5	105	380	158	13.7	23	0.18
12x1,5		1.5	20	21.4	128	550	270	13.7	23	0.18
18x1,5		1.5	22.4	23.8	143	730	405	13.7	23	0.18
24x1,5		1.5	25.4	27	162	950	540	13.7	23	0.18
30x1,5		1.5	27.8	29.4	176	1140	675	13.7	23	0.18
42x1,5		1.5	33.3	35.3	212	1560	945	13.7	23	0.18
7x2,5		2	18.5	19.7	118	510	263	8.21	30	0.31
12x2,5		2	22.7	24.0	145	740	450	8.21	30	0.31
18x2,5	20162064	2	25.8	27.4	164	1020	675	8.21	30	0.31
24x2,5		2	30.1	32.1	193	1410	900	8.21	30	0.31
30x2,5		2	31.9	33.9	203	1570	1125	8.21	30	0.31
NSHTOEU-J power cables, three core design										
3x50+3x25/3		9.6	41	45	270	2850	2250	0.39	202	6.1
3x70+3x35/3		11.1	43	47	282	3860	3150	0.28	250	8.54
3x95+3x50/3		12.6	48	52	312	4720	4275	0.21	301	11.59
3x120+3x70/3		13.7	50.5	55.5	333	5820	5400	0.16	352	14.64
3x150+3x70/3		16	57	62	372	6535	6750	0.13	404	18.3
3x185+3x95/3		17.7	63	68	408	8890	8325	0.11	461	22.57
3x240+3x95/3		20.2	71	76	456	12040	10800	0.08	540	29.28
NSHTOEU-J power cables, four core design										
4x1,5		1.5	12.2	13.4	80	210	90	13.7	23	0.18
4x2,5		2	15.3	16.5	99	320	150	8.21	30	0.31
4x4		2.5	17.0	18.3	110	430	240	5.09	41	0.49
4x6		3	18.4	19.6	118	530	360	3.39	53	0.73
4x10		4.1	22.8	24.2	145	840	600	1.95	74	1.22
4x16		5.7	27.5	29.1	175	1190	960	1.24	99	1.95
4x25		7.2	33.5	35.5	213	1940	1500	0.8	131	3.05
4x35		8.2	35.9	38.3	230	2220	2100	0.57	162	4.27
NSHTOEU-J power cables, five core design										
5x1,5		1.5	13.4	14.6	88	250	113	13.7	23	0.18
5x2,5	20160147	2	16.2	17.5	105	380	188	8.21	30	0.31
5x4		2.5	18.2	19.5	117	490	300	5.09	41	0.49
5x6		3	20.4	21.8	131	650	450	3.39	53	0.73
5x10		4.1	24.4	26	156	1190	750	1.95	74	1.22
5x16		5.7	29.4	31.4	188	1460	1200	1.24	99	1.95
5x25		7.2	36	38.4	230	2130	1875	0.8	131	3.05
5x35		8.2	40.1	42.6	256	2810	2625	0.57	162	4.27

(1) Nominal current carrying capacity for rubber cables laid on a surface, at 30°C ambient temperature (see also VDE 0298-4, Table 15). For articles without part number the values shown are approximate, and need to be confirmed in case of order.



## EASYFLEX (N)7YRDGOEU

Cable for simple reeling application

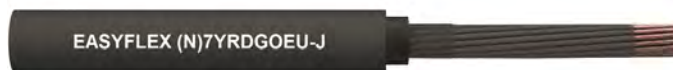

### Application

Connection cable for use on spring cable reels. Typical applications in wastewater treatment plants, as well as for simple reeling operating in indoor and outdoor areas.

### Global data

Brand	EASYFLEX
Type designation	(N)7YRDGOEU-J

### Design features

Conductor	Bare electrolytic copper, very finely stranded, class FS
Insulation	ETFE for good mechanical and electrical characteristics (see also DIN VDE 0207)
Core identification	Black colored insulation with numbers printed in white, earth conductor green-yellow
Core arrangement	Laid-up in layers
Inner sheath	Basic material EPR, color: black
Outer sheath	Basic material EVA, color: black
Marking	EASYFLEX (N)7YRDGOEU-J (nr. of cores)x(cross-section) 0,6/1 kV

### Electrical parameters

Rated voltage	0.6/1 kV (600/1000V)
Max. permissible operating voltage AC	0.7/1.2 kV
Max. permissible operating voltage DC	0.9/1.8 kV
AC Test Voltage	3.5 kV (5 Min.)
Current Carrying Capacity description	Acc. to DIN VDE 0298-4

### Thermal parameters

Max. permissible temperature at conductor	90 °C
Max. short circuit temperature of the conductor	250 °C
Ambient temperature for fixed installation	min -50 °C ; max +80 °C
Ambient temperature in fully flexible operation	min -35 °C ; max +80 °C

### Mechanical parameters

Max. tensile load on the conductor	15 N/mm <sup>2</sup>
Torsional stress	± 15 °/m
Min. bending radius	6 x D
Travel speed	- Reeling operation: 80 m/min
Additional tests	Reversed bending test, reeling test

Number of cores x cross section	Part number	MLFB Number	Conductor diameter max. mm	Outer diameter min. mm	Outer diameter max. mm	Bending radius free moving min. mm	Weight (ca.) kg/km	Permissible tensile force max. N	Conductor resistance at 20°C max. Ω/km	Current carrying capacity (1) A	Short Circuit Current (conductor) kA
<b>(N)7YRDGOEU-J Control cables</b>											
7x1,5		5DG4***	1.6	13.6	15	90	300	150	13.3	23	0.21
12x1,5		5DG4***	1.6	15.1	17.1	103	425	270	13.3	23	0.21
18x1,5		5DG4***	1.6	17.4	19.4	116	580	400	13.3	23	0.21
24x1,5		5DG4***	1.6	21.4	23.4	140	830	540	13.3	23	0.21
4x2,5		5DG4***	2	12	13.6	82	265	150	7.98	30	0.36
5x2,5		5DG4***	2	12.9	14.5	87	310	180	7.98	30	0.36
7x2,5		5DG4***	2	14.6	16.6	100	415	260	7.98	30	0.36
12x2,5	20025880	5DG4522	2	16.7	18.7	112	575	450	7.98	30	0.36
18x2,5	20025881	5DG4523	2	19.3	21.3	128	795	670	7.98	30	0.36
24x2,5		5DG4***	2	24.1	26.1	157	1115	900	7.98	30	0.36
<b>(N)7YRDGOEU-J Power cables</b>											
4x4		5DG4***	3	14.3	16.3	98	360	240	4.95	41	0.57
5x4		5DG4***	3	15.4	17.4	104	435	300	4.95	41	0.57
4x6		5DG4***	3.6	15.7	17.7	106	470	360	3.3	53	0.86
5x6		5DG4***	3.6	16.9	18.9	113	555	450	3.3	53	0.86
4x10		5DG4***	4.6	18.1	20.1	121	690	600	1.91	74	1.43
5x10		5DG4***	4.6	19.7	21.7	130	820	750	1.91	74	1.43
4x16		5DG4***	5.6	21.9	23.9	143	1035	960	1.21	99	2.29
5x16		5DG4***	5.6	23.8	25.8	155	1240	1200	1.21	99	2.29

# Crane cables



# LOW VOLTAGE REELING CABLES FOR E-RTG'S

	<b>CORDAFLEX (SMK)</b>	<b>TROMMELFLEX KSM-S</b>
Designation	(N)SHTOEU	(N)SHTOEU
Dimension	Based on DIN VDE 0250 part 814	Based on DIN VDE 0250 part 814
Cores	Power: 3C+3G	Power: 3C+3C
Outer Sheath	Rubber	Rubber
Approvals	VDE Reg. GOST-R	
Tensile Load	30 N/mm <sup>2</sup>	20 N/mm <sup>2</sup>
Speed	240 m/min	180 m/min
Temp. (moving)	-35°C/+80°C (special to -45°C on request)	-40°C/+80°C

## CORDAFLEX(SMK) (N)SHTOEU

Low voltage reeling cable for E-RTG's



### Application

Flexible low voltage reeling cable for power supply (also with integrated fiber optics), suitable for application under high and very high mechanical stresses. The main application is reeling operation on ERTG's (Electrified Rubber Tyred Gantry cranes).

### Global data

Brand	CORDAFLEX(SMK)
Type designation	(N)SHTOEU-J/-O
Standard	Based on DIN VDE 0250-814
Certifications / Approvals	VDE Reg. Nr. 7519; GOST-R

### Notes on installation

Notes on installation	Preparation of fibre-optics requires special skills and use of elaborate tools. It is therefore recommended that performance of this work is entrusted to our customer service (Factory assembly). Please provide the connection dimensions.
-----------------------	--

### Design features

Conductor	Electrolytic copper tinned, very finely stranded class FS																																								
Insulation	PROTOLON MS Special compound based on high-quality EPR (min. 3GI3); improved mechanical and electrical characteristics.																																								
Core identification	Best identification as a result of light colored insulation with numbers printed in black for power and control cables, earth conductor green-yellow colored.																																								
Optical Fiber	Fibre core diameter: 62.5, 50 or 9µm; diameter across the cladding: 125µm; diameter over the coating: 250µm. Design available with 6,12, 18 or 24 fibres.																																								
	<table border="1"> <thead> <tr> <th>Fibre class:</th> <th>G50/125µm</th> <th>G62,5/125µm</th> <th>E9/125µm</th> </tr> <tr> <th>Type:</th> <td>Graded-index fibre</td> <td>Graded-index fibre</td> <td>Monomode fibre</td> </tr> </thead> <tbody> <tr> <td>- Attenuation at 850 nm:</td> <td>&lt;2,8 dB/km</td> <td>&lt;3,3 dB/km</td> <td>-</td> </tr> <tr> <td>- Attenuation at 1310 nm:</td> <td>&lt;0,8 dB/km</td> <td>&lt;0,9 dB/km</td> <td>&lt;0,4 dB/km</td> </tr> <tr> <td>- Attenuation at 1550 nm:</td> <td>-</td> <td>-</td> <td>&lt;0,3 dB/km</td> </tr> <tr> <td>- Bandwidth at 850 nm:</td> <td>&gt;400 MHz</td> <td>&gt;400 MHz</td> <td>-</td> </tr> <tr> <td>- Bandwidth at 1300 nm:</td> <td>&gt;1200 MHz</td> <td>&gt;600 MHz</td> <td>-</td> </tr> <tr> <td>- Numerical aperture:</td> <td>0,2 ± 0,02</td> <td>0,275 ± 0,02</td> <td>0,14 ± 0,02</td> </tr> <tr> <td>- Chromatic dispersion at 1300 nm:</td> <td>-</td> <td>-</td> <td>&lt;3,5 ps/nm km</td> </tr> <tr> <td>- Chromatic dispersion at 1550 nm:</td> <td>-</td> <td>-</td> <td>&lt;3,5 ps/nm km</td> </tr> </tbody> </table>	Fibre class:	G50/125µm	G62,5/125µm	E9/125µm	Type:	Graded-index fibre	Graded-index fibre	Monomode fibre	- Attenuation at 850 nm:	<2,8 dB/km	<3,3 dB/km	-	- Attenuation at 1310 nm:	<0,8 dB/km	<0,9 dB/km	<0,4 dB/km	- Attenuation at 1550 nm:	-	-	<0,3 dB/km	- Bandwidth at 850 nm:	>400 MHz	>400 MHz	-	- Bandwidth at 1300 nm:	>1200 MHz	>600 MHz	-	- Numerical aperture:	0,2 ± 0,02	0,275 ± 0,02	0,14 ± 0,02	- Chromatic dispersion at 1300 nm:	-	-	<3,5 ps/nm km	- Chromatic dispersion at 1550 nm:	-	-	<3,5 ps/nm km
Fibre class:	G50/125µm	G62,5/125µm	E9/125µm																																						
Type:	Graded-index fibre	Graded-index fibre	Monomode fibre																																						
- Attenuation at 850 nm:	<2,8 dB/km	<3,3 dB/km	-																																						
- Attenuation at 1310 nm:	<0,8 dB/km	<0,9 dB/km	<0,4 dB/km																																						
- Attenuation at 1550 nm:	-	-	<0,3 dB/km																																						
- Bandwidth at 850 nm:	>400 MHz	>400 MHz	-																																						
- Bandwidth at 1300 nm:	>1200 MHz	>600 MHz	-																																						
- Numerical aperture:	0,2 ± 0,02	0,275 ± 0,02	0,14 ± 0,02																																						
- Chromatic dispersion at 1300 nm:	-	-	<3,5 ps/nm km																																						
- Chromatic dispersion at 1550 nm:	-	-	<3,5 ps/nm km																																						
Fiber coding	Specially developed color code for identification of the individual fibres																																								
Fiber covering	Hollow core with filling compound, Basic material: ETFE, Compound: 7YI 1, Natural color																																								
Core arrangement	Laid-up in a maximum of 3 layers																																								
Sheath system	- PROTOFIRM Special - Inner sheath: High grade special compound based on PCP, color: yellow; - Anti-torsion braid: Reinforced braid made of polyester threads, in a vulcanized bond between the sheaths, resulting in a high strength of the sheath system; - PROTOFIRM Special - Outer sheath: A sheath system with a unique combination of flexibility and robustness has been achieved through the use of this structure. Abrasion and tear resistant special rubber compound based on PCP, color: yellow.																																								
Marking	CORDAFLEX (SMK) (N)SHTOEU -J/-O (number of cores) x (cross section)+VDE Reg.-Nr.																																								

### Electrical parameters

Rated voltage	0.6/1 kV (600/1000V)
Max. permissible operating voltage AC	0.7/1.2 kV
Max. permissible operating voltage DC	0.9/1.8 kV
AC Test Voltage	3.5 kV (5 Min.)
Data transmission	Special design with fibre-optics for trouble free data transmission at high data rates.
Current Carrying Capacity description	Acc. to DIN VDE 0298-4

---

#### Chemical parameters

Resistance to oil	Acc. to DIN EN 60811-404; DIN VDE 0473-811-404, paragraph 10
Weather resistance	Unrestricted use outdoors and indoors, resistant to ozone, UV and moisture.
Water resistance	Given and verified in long-term tests

---

#### Thermal parameters

Max. permissible temperature at conductor	90 °C
Max. short circuit temperature of the conductor	250 °C
Ambient temperature for fixed installation	min -50 °C ; max +80 °C
Ambient temperature in fully flexible operation	min -35 °C ; max +80 °C

---

#### Mechanical parameters

Max. tensile load on the conductor	30 N/mm <sup>2</sup>
Torsional stress	± 50 °/m
Min. bending radius	Acc. to DIN VDE 0298 part 3
Min. distance with S-type directional changes	20 X D
Travel speed	- Gantry (reeling operation): no restriction. It is recommended to consult the manufacturer for speeds beyond 240m/min; - Trolley (festoon operation): up to 240 m/min.
Additional tests	Reversed bending test, roller bending test, torsional stress test.

Number of cores x cross section	Part number	MLFB Number	Conductor diameter max. mm	Outer diameter min. mm	Outer diameter max. mm	Bending radius free moving min. mm	Weight (ca.) kg/km	Permissible tensile force max. N	Conductor resistance at 20°C max. Ω/km	Current carrying capacity (1) A	Short Circuit Current (conductor) kA
(N)SHTOEU-J power cables, 3-core design, earth conductor split in three											
3x35+3x16/3	20004037	5DH3121	8.4	28.7	31.7	159	1990	3150	0.57	162	5.01
3x50+3x25/3	20004038	5DH3122	10.3	34.4	37.4	187	2810	4500	0.39	202	7.15
3x70+3x35/3	20004039	5DH3123	12	39.7	42.7	214	3860	6300	0.28	250	10.01
3x95+3x50/3	20004040	5DH3124	14	44.3	47.3	237	4950	8550	0.21	301	13.59
3x120+3x70/3	20004041	5DH3125	15.8	51	55	275	6440	10800	0.16	352	17.16
3x150+3x70/3	20004042	5DH3126	17.5	53.9	57.9	290	7500	13500	0.13	404	21.45
3x185+3x95/3	20004043	5DH3127	19.4	58.9	62.9	315	8990	16650	0.11	461	26.46
3x240+3x120/3	20004044	5DH3128	22.5	67.4	71.4	357	11940	21600	0.08	540	34.32
3x300+3x150/3	20051390	5DH3119	25.2	75.6	79.6	398	14740	27000	0.07	620	42.9
(N)SHTOEU-J 3-core design power cables with FO, earth conductor splitted in two											
3x35 + 2x16/2 + 1x(6G62,5)		5DH3***	8.4	35.7	38.7	194	2390	3150	0.57	162	5.01
3x50 + 2x25/2 + 1x(6G62,5)		5DH3***	10.3	39.9	42.9	215	3220	4500	0.39	202	7.15
3x70 + 2x35/2 + 1x(6G62,5)		5DH3***	12	43.7	46.7	234	4200	6300	0.28	250	10.01
3x95 + 2x50/2 + 1x(6G62,5)		5DH3***	14	47.6	50.6	253	5220	8550	0.21	301	13.59
3x120 + 2x70/2 + 1x(6G62,5)		5DH3***	15.8	54	58	290	6700	10800	0.16	352	17.16
3x150 + 2x70/2 + 1x(6G62,5)		5DH3283	17.5	57	61	305	7750	13500	0.13	404	21.45
3x185 + 2x95/2 + 1x(6G62,5)	20155139	5DH3284	19.4	59.5	63.5	318	9200	16650	0.11	461	26.46
3x240 + 2x120/2 + 1x(6G62,5)	20168346	5DH3***	22.5	69.7	73.7	369	12320	21600	0.08	540	34.32
3x300 + 2x150/2 + 1x(6G62,5)		5DH3***	25.2	78	82	410	15000	27000	0.07	620	42.9

(1) Nominal current carrying capacity for rubber cables laid on a surface, at 30°C ambient temperature (see also VDE 0298-4, Table 15). Design with 12,18 or 24 fibers and/or G50 or E9 types available upon request.





## TROMMELFLEX (KSM-S) (N)SHTOEU: Low voltage reeling cable for E-RTG's



### Application

Flexible low voltage reeling cable for power supply (also with integrated fiber optics), suitable for application under high mechanical stresses. The main application is reeling operation on ERTG's (Electrified Rubber Tyred Gantry cranes).

### Global data

Brand	TROMMELFLEX KSM-S
Type designation	(N)SHTOEU-J/-O
Standard	Based on DIN VDE 0250-814

### Design features

Conductor	Plain copper, flexible class 5 acc. to DIN EN 60228 / DIN VDE 0295			
Insulation	Rubber compound type 3GI3 acc. to DIN VDE 0207-20			
Core identification	Acc. to DIN VDE 0293-308			
Optical Fiber	12 fibers, 50/125µ or 62.5/125µ or E9/125µ, within protection jacket.			
	Fibre class:	G50/125µm	G62,5/125µm	E9/125µm
	Type:	Graded-index fibre	Graded-index fibre	Monomode fibre
	- Attenuation at 850 nm:	<2,8 dB/km	<3,3 dB/km	-
	- Attenuation at 1300 nm:	<0,8 dB/km	<0,9 dB/km	<0,4 dB/km
	- Attenuation at 1550 nm:	-	-	<0,3 dB/km
	- Bandwidth at 850 nm:	>400 MHz	>200 MHz	-
	- Bandwidth at 1300 nm:	>1200 MHz	>500 MHz	-
	- Numerical aperture:	0,2 ± 0,02	0,27 ± 0,02	-
	- Chromatic dispersion at 1300 nm:	-	-	<3,5 ps/nm km
	- Chromatic dispersion at 1550 nm:	-	-	<18 ps/nm km
Core arrangement	Cores laid up with short length of lay. Split earth conductor and optical element positioned in the interstices.			
Inner sheath	Rubber compound type 5GM3 acc. to DIN VDE 0207-21			
Reinforcement	Wide- meshed polyester braid, embedded in the sheath			
Outer sheath	Extruded rubber compound type 5GM5 acc. to DIN VDE 0207-21. Abrasion and tear resistant, oil and flame resistant; Colour: black			
Marking	White imprint: TROMMELFLEX KSM-S (N)SHTOEU-J (number of cores) x (cross-section) (week/year)			

### Electrical parameters

Rated voltage	0.6/1 kV (600/1000V)
Max. permissible operating voltage AC	0.7/1.2 kV
Max. permissible operating voltage DC	0.9/1.8 kV
AC Test Voltage	4 kV (5 Min.)
Data transmission	Fibre-optic element for trouble free data transmission
Current Carrying Capacity description	Acc. to DIN VDE 0298-4

### Chemical parameters

Resistance to fire	Acc. to IEC 60332-1 (EN 50265-2-1)
Resistance to oil	Acc. to EN 60811-404 - ASTM No. 2: 24h at 100 °C

### Thermal parameters

Max. permissible temperature at conductor	90 °C
Max. short circuit temperature of the conductor	250 °C
Ambient temperature for fixed installation	min -40 °C ; max +80 °C
Ambient temperature in fully flexible operation	min -40 °C ; max +80 °C

---

#### Mechanical parameters

Max. tensile load on the conductor	20 N/mm <sup>2</sup>
Torsional stress	± 50 °/m
Min. bending radius	Acc. to DIN VDE 0298 part 3
Min. distance with S-type directional changes	20 X D
Travel speed	- Reeling operation: up to 180m/min

Number of cores x cross section	Part number	Conductor diameter max. mm	Outer diameter min. mm	Outer diameter max. mm	Bending radius free moving min. mm	Weight (ca.) kg/km	Permissible tensile force max. N	Conductor resistance at 20°C max. Ω/km	Current carrying capacity (1) A	Short Circuit Current (conductor) kA
(N)SHTOEU-J power cables, 3-core design, earth conductor splitted in three										
3x50+3x25/3	20166655	9.6	34	37	185	2550	3000	0.39	202	7.15
3x95+3x50/3	20164198	12.6	43	46	230	4340	5700	0.21	301	13.59
3x70+3x35/3		11.1	40	43	215	3460	4200	0.27	250	10.01
3x120+3x70/3		14.8	51	56	280	5630	7200	0.16	352	17.16
3x150+3x70/3	20161381	16	52	56	280	6500	9000	0.13	404	21.45
3x185+3x95/3		17.7	56	61	305	7910	11100	0.11	461	26.46
3x240+3x120/3	20160696	20.2	64	70	350	10380	14400	0.08	540	34.32
3x300+3x150/3	20074322	22.7	70	76	380	13220	18000	0.06	620	42.9
3x400+3x240/3		27	82	88	440	20750	24000	0.05	715	57.2
(N)SHTOEU-J power cables, 3-core design with FO, earth conductor splitted in two										
3x35 + 2x16/2 + 12LWL		7.8	33.5	36.5	183	2110	2100	0.55	162	5.01
3x50 + 2x25/2 + 12G62,5	20166541	9	39.5	42.5	213	2910	3000	0.39	202	7.15
3x70 + 2x35/2 + 12LWL		11.1	40	43	215	3380	4200	0.27	250	10.01
3x95 + 2x50/2 + 12LWL		12.6	43	46	230	4230	5700	0.21	301	13.59
3x120 + 2x70/2 + 12G62,5	20165663	14.8	48.5	52.5	263	5650	7200	0.16	352	17.16
3x150 + 2x70/2 + 12G62,5	20129614	16	54	58	290	6570	9000	0.13	404	21.45
3x185 + 2x95/2 + 12G62,5	20165664	17.7	56	61	305	8010	11100	0.11	461	26.46
3x240 + 2x120/2 + 12G62,5	20166701	20.2	64	70	350	9980	14400	0.08	540	34.32
3x300 + 2x150/2 + 12LWL		22.7	70	76	380	12560	18000	0.06	620	42.9

(1) Nominal current carrying capacity for rubber cables laid on a surface, at 30°C ambient temperature (see also VDE 0298-4, Table 15). For articles without part number the values shown are approximate, and need to be confirmed in case of order.



# Crane cables

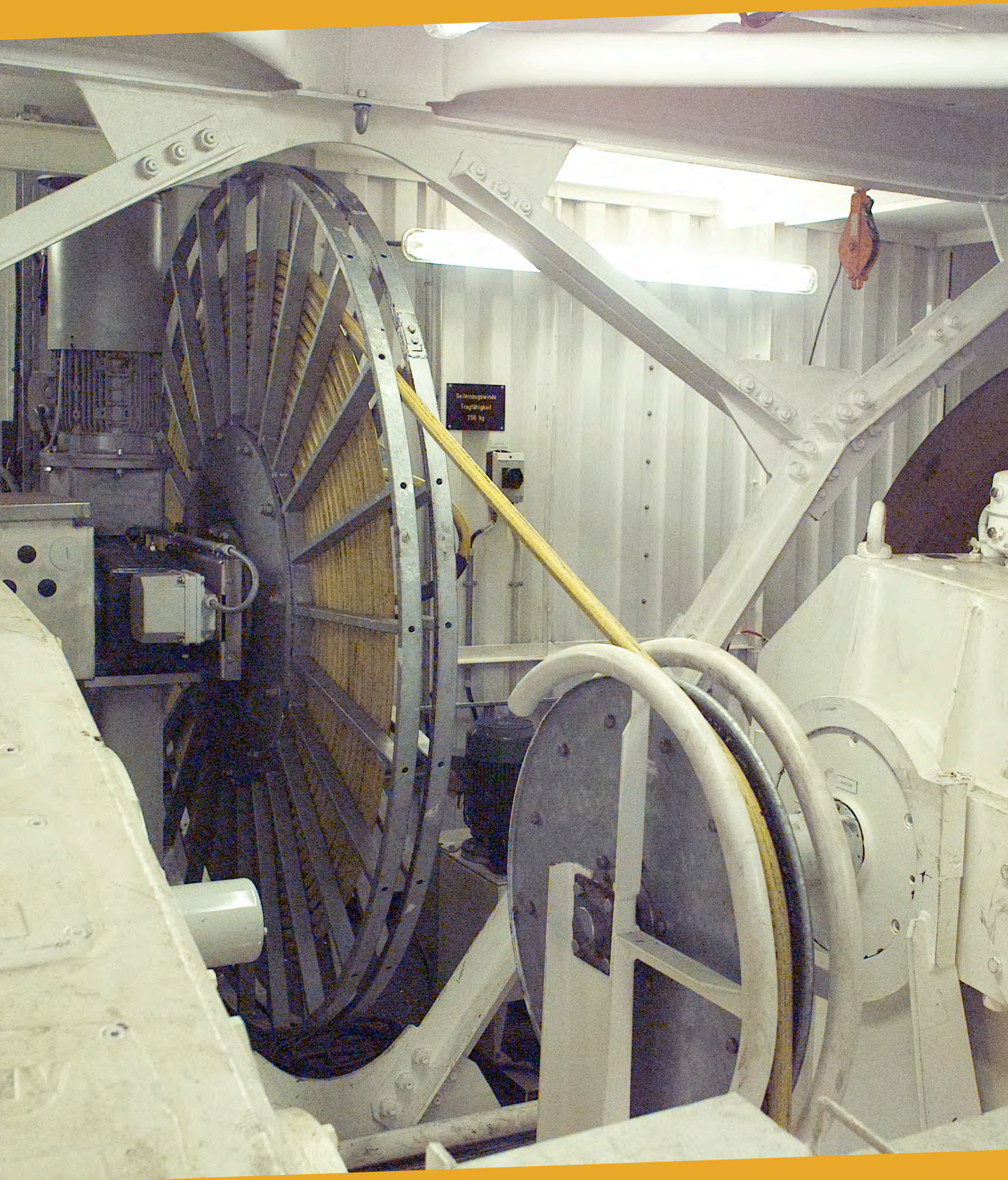

# LOW VOLTAGE CABLES FOR VERTICAL REELING

	<b>CORDAFLEX (SMK)-V</b>	<b>SPREADER REEL PUR HF</b>
Designation	(N)SHTOEU	D12YST11YU11Y
Dimension	Based on DIN VDE 0250 part 814	Optimized
Cores	Control: multicores (also with LWL)	Control: multicores
Outer Sheath	Rubber	PUR
Approvals	GOST-R	
Tensile Load	30 N/mm <sup>2</sup> + aramid support element	30 N/mm <sup>2</sup> + aramid support element
Speed	240 m/min	180 m/min
Temp. (moving)	-35°C/+80°C (special to -45°C on request)	-40°C/+80°C

## CORDAFLEX(SMK)-V (N)SHTOEU

Low voltage cable for vertical reeling



### Application

Flexible low voltage reeling cable for application under extreme mechanical stresses, specially designed for vertical reeling operation (spreader reeling application).

### Global data

Brand	CORDAFLEX(SMK)-V
Type designation	(N)SHTOEU-J/-O
Standard	Based on DIN VDE 0250-814
Certifications / Approvals	GOST-R

### Design features

Conductor	Electrolytic bare copper, very finely stranded class FS
Insulation	Special thermoplastic compound providing very high stability, best insulation resistance and excellent gliding characteristic
Core identification	Best identification as a result of black colored insulation with light printed numbers, earth conductor green-yellow
Individual screen	Braid screen made of tinned copper wires. Transfer impedance optimized at 30 MHz. Surface covered: at least 60% for shielded cores; at least 80% for twisted pairs
Core arrangement	Laid-up in a maximum of 3 layers
Support element	Central aramide support element to increase the loading capability. The kN value designates the breaking load of the support element
Sheath system	- PROTOFIRM Special - Inner sheath: High grade special compound based on PCP, color: yellow; - Anti-torsion braid: Reinforced braid made of polyester threads, in a vulcanized bond between the sheaths, resulting in a high strength of the sheath system; - PROTOFIRM Special - Outer sheath: A sheath system with a unique combination of flexibility and robustness has been achieved through the use of this structure. Abrasion and tear resistant special rubber compound based on PCP, color: yellow.
Marking	CORDAFLEX (SMK)-V (N)SHTOEU-J/-O (number of cores)x(cross-section)

### Electrical parameters

Rated voltage	0.6/1 kV (600/1000V)
Max. permissible operating voltage AC	0.7/1.2 kV
Max. permissible operating voltage DC	0.9/1.8 kV
AC Test Voltage	3.5 kV (5 Min.)
Data transmission	With special elements: ASI-Bus, Profibus, CAN-Bus, Industrial Ethernet. Alternatively: fibre optics for transmitting all bus protocols.
Current Carrying Capacity description	Acc. to DIN VDE 0298-4

### Chemical parameters

Resistance to oil	Acc. to DIN EN 60811-404; DIN VDE 0473-811-404, paragraph 10
Weather resistance	Unrestricted use outdoors and indoors, resistant to ozone, UV and moisture
Water resistance	Given and verified in long-term tests

### Thermal parameters

Max. permissible temperature at conductor	90 °C
Max. short circuit temperature of the conductor	250 °C
Ambient temperature for fixed installation	min -50 °C ; max +80 °C
Ambient temperature in fully flexible operation	min -35 °C ; max +80 °C

### Mechanical parameters

Max. tensile load	Increased tensile load through additional support elements (see table).
Torsional stress	± 50 °/m
Min. bending radius	Acc. to DIN VDE 0298 part 3
Min. distance with S-type directional changes	20 X D
Travel speed	Hoist (vertical reeling): up to 240 m/min. It is recommended to consult the manufacturer for speeds beyond 240 m/min.
Additional tests	Reversed bending test, roller bending test, torsional stress test

Number of cores x cross section	Part number	MLFB Number	Conductor diameter max. mm	Outer diameter min. mm	Outer diameter max. mm	Bending radius free moving min. mm	Weight (ca.) kg/km	Permissible tensile force max. N	Conductor resistance at 20°C max. Ω/km	Current carrying capacity (1) A	Short Circuit Current (conductor) kA
<b>(N)SHTOEU-J control cables</b>											
49x1	20004108	5DH3291	1.3	26.6	29.6	148	1250	3200	19.5	18	0.14
12x2,5	20004109	5DH3292	2	22	25	125	870	2700	7.98	30	0.36
24x2,5	20004112	5DH3295	2	26.2	29.2	146	1300	3600	7.98	30	0.36
30x2,5	20004113	5DH3296	2	29.4	32.4	162	1630	4100	7.98	30	0.36
44x2,5	20004115	5DH3298	2	34.1	37.1	186	2200	5100	7.98	30	0.36
56x2,5	20004107	5DH3290	2	40.1	43.1	216	2960	6000	7.98	30	0.36
<b>(N)SHTOEU composite control cables</b>											
12x2,5+(4x0,5)C	20008558	5DH3262	2	19	22	110	770	2700	7.98	30	0.36
45x2,5+(4x0,5)C	20163404	5DH3286	2	42.9	45.9	230	2830	5175	7.98	30	0.36
<b>(N)SHTOEU-J control cables with FO</b>											
22x2,5+4x(3G50)	20004111	5DH3294	2	28.2	31.2	156	1390	3450	7.98	30	0.36
22x2,5+2x(3G62,5)	20008607	5DH3261	2	26.2	29.2	146	1260	3450	7.98	30	0.36
24x2,5+6x(2G62,5)	20079358	5DH3981	2	29.4	32.4	162	1510	3600	7.98	30	0.36
28x2,5+2x(3G62,5)	20156011	5DH3308	2	29.4	32.4	162	1590	3900	7.98	30	0.36
28x2,5+2x(3G50)	20149375	5DH3305	2	29.4	32.4	162	1590	3900	7.98	30	0.36
36x2,5+8x(1G62,5)	20091976	5DH3978	2	34.1	37.1	186	2050	4500	7.98	30	0.36
38x2,5+6x(2G62,5)	20040061	5DH3259	2	34.1	37.1	186	2090	4650	7.98	30	0.36
41x2,5+3x(2G62,5)	20116888	5DH3301	2	34.1	37.1	186	2150	4875	7.98	30	0.36
41x2,5+3x(2G50)	20142021	5DH3304	2	34.1	37.1	186	2160	4875	7.98	30	0.36
42x2,5+2x(3G62,5)	20081032	5DH3980	2	34.1	37.1	186	2170	4950	7.98	30	0.36
44x2,5+3x(2G62,5)	20155500	5DH3314	2	35.5	38.5	193	2300	5100	7.98	30	0.36
44x2,5+4x(3G62,5)	20160144	5DH3315	2	35.5	38.5	193	2330	5100	7.98	30	0.36
44x2,5+3x(3G50)	20025456	5DH3300	2	35.5	38.5	193	2310	5100	7.98	30	0.36
44x2,5+3x(3G62,5)	20143212	5DH3313	2	35.5	38.5	193	2310	5100	7.98	30	0.36
50x2,5+6x(1G50)	20004095	5DH3269	2	40.1	43.1	216	2840	5550	7.98	30	0.36
52x2,5+4x(3G62,5)	20080536	5DH3979	2	40.1	43.1	216	2890	5700	7.98	30	0.36
56x2,5+3x(3G62,5)	20004096	5DH3270	2	41.3	44.3	222	3030	6000	7.98	30	0.36
56x2,5+4x(3G62,5)	20085758	5DH3258	2	41.3	44.3	222	3080	6000	7.98	30	0.36

(1) Nominal current carrying capacity for rubber cables laid on a surface, at 30°C ambient temperature (see also VDE 0298-4, Table 15). Additional special design with integrated fiber optics upon request.



## SPREADER REEL PUR-HF D12YST11YU11Y

Low voltage cable PUR sheathed for vertical reeling



### Application

Flexible low voltage reeling cable for application under high mechanical stresses, specially designed for vertical reeling operation (spreader reeling application).

### Global data

Brand	SPREADER REEL
Type designation	D12YST11YU11Y-JZ

### Design features

Conductor	Plain copper, flexible class 5 acc. to DIN EN 60228 / DIN VDE 0295
Insulation	Halogen free compound, based on polyester
Core identification	White with black numbers, similar to HD 308
Core arrangement	Central aramid strain element; cores twisted in layers with short length of lay
Inner sheath	Polyurethan, halogen free, flame retardant
Reinforcement	Open braid, reinforced
Outer sheath	Polyurethane, halogen free, flame retardant, opaque; Colour: black
Marking	White imprint: D12YST11YU11Y-JZ PUR-HF SPEZIAL (number of cores) x (cross-section) DRAKA DE (week/year)

### Electrical parameters

Rated voltage	0.6/1 kV (600/1000V)
Max. permissible operating voltage AC	0.7/1.2 kV
Max. permissible operating voltage DC	0.9/1.8 kV
AC Test Voltage	4 kV (5 Min.)
Current Carrying Capacity description	Acc. to DIN VDE 0298-4

### Chemical parameters

Resistance to fire	Similar to IEC 60332-1
Resistance to oil	According to EN 60811-404
Water resistance	The cables are suitable for permanent use in water (no drinking water) up to 50 meter diving depth.

### Thermal parameters

Max. permissible temperature at conductor	90 °C
Max. short circuit temperature of the conductor	250 °C
Ambient temperature for fixed installation	min -50 °C ; max +80 °C
Ambient temperature in fully flexible operation	min -40 °C ; max +80 °C

### Mechanical parameters

Max. tensile load	Increased tensile load through additional support elements (see table).
Torsional stress	± 50 °/m
Min. bending radius	6 x D (Proved by flexing tests acc. to HD 22.2 part 3.1)
Min. distance with S-type directional changes	20 x D
Travel speed	- Vertical reeling: up to 180 m/min

Number of cores x cross section	Part number	Conductor diameter max. mm	Outer diameter min. mm	Outer diameter max. mm	Bending radius free moving min. mm	Weight (ca.) kg/km	Permissible tensile force max. N	Conductor resistance at 20°C max. Ω/km	Current carrying capacity (1) A	Short Circuit Current (conductor) kA
24x2,5	20074331	2	23.8	25.2	151	980	3000	7.98	30	0.36
30x2,5	20074131	2	25.8	27.4	164	1290	3375	7.98	30	0.36
36x2,5	20074356	2	30.2	32.2	193	1530	3750	7.98	30	0.36
42x2,5	20074550	2	34.1	36.5	219	1940	4125	7.98	30	0.36
44x2,5	20119442	2	36.1	38.5	231	2080	4250	7.98	30	0.36
9x(5x2,5)		2	38.8	41.2	247	2150	3810	7.98	30	0.36
8x(6x2,5)	20076165	2	42.7	45.1	271	2620	4000	7.98	30	0.36
14x(4x2,5)	20161383	2	40	42.4	254	2410	4000	7.98	30	0.36

(1) Nominal current carrying capacity for rubber cables laid on a surface, at 30°C ambient temperature (see also VDE 0298-4, Table 15). For articles without part number the values shown are approximate, and need to be confirmed in case of order.

The tensile loads values given are valid for systems where kellum grips are used to take the tensile load on the head block. In case of different application please contact the manufacturer.

# Crane cables

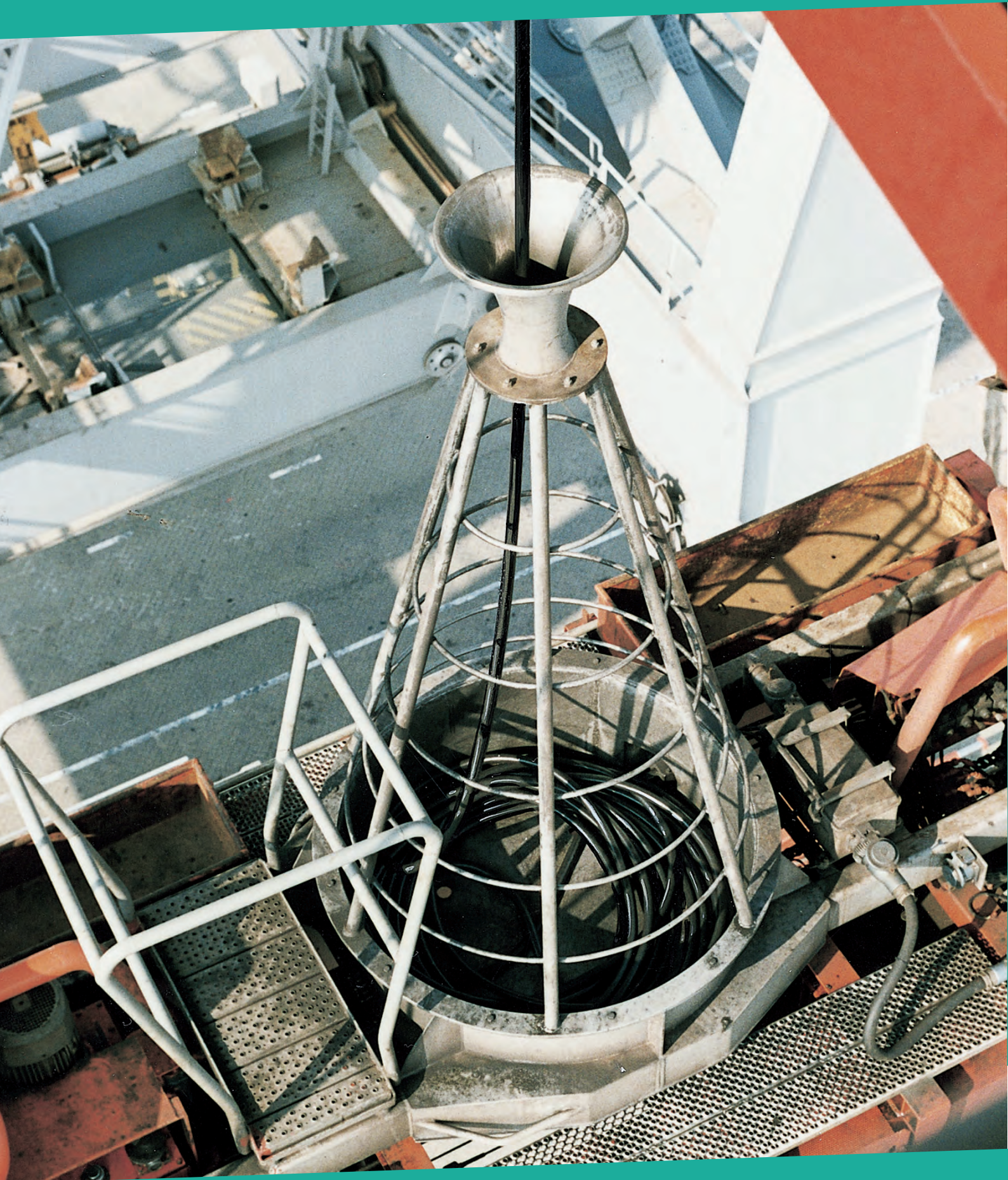

# LOW VOLTAGE CABLES FOR BASKET OPERATION

## SPREADERFLEX

Designation	3GSLTOE-J/-0
Dimension	Based on VDE 0250
Cores	Control: multicores (also with LWL or TSP)
Outer Sheath	PUR
Approvals	VDE
Tensile Load	Increased tensile load through additional support element
Speed	160 m/min
Temp. (moving)	-40°C/+80°C

## SPREADERFLEX 3GSLTOE 0.6/1kV

### Spreader cable for basket operation



#### Application

Feeder cable for load-lifting equipment, e.g. spreader with high mechanical stress in gravity-fed collector basket operation, with voltage rate up to 0,6/1 kV. Suitable for operation in cold environment.

#### Global data

Brand	SPREADERFLEX
Type designation	3GSLTOE-J/-O
Standard	based on DIN VDE 0250
Certifications / Approvals	GOST-R

#### Notes on installation

Notes on installation	Cable must be laid into the basket in a counter-clockwise direction; detailed installation instructions available upon request.
-----------------------	---

#### Design features

Conductor	Bare Electrolytic copper, extremely fine stranded, class FS
Insulation	Special EPR compound based on type 3GI3 acc. DIN VDE 0207; for application in ambient temperatures down to -40°C
Core identification	Optimal identification as a result of light colored insulation with numbers printed in black; protective earth conductor green/yellow
Individual screen	Braid screen made of tinned copper wires. Transfer impedance optimized at 30 MHz. Surface covered: at least 60% for shielded cores; at least 80% for twisted pairs
Core arrangement	Core assembly: cores laid-up into bundles; Bundle assembly: bundles laid-up around the central support element.
Support element	Aramide threads woven round lead ball cords, arranged centrally. The breaking load is rated to provide a safety factor of 5 when the cable is suspended vertically for 50 m. In case of bigger cross-section and higher number of cores, the support element is a round rubber filler with Aramid threads.
Outer sheath	Special PUR compound; Colour: black
Marking	SPREADERFLEX 3GSLTOE-J (number of cores) x (cross-section)

#### Electrical parameters

Rated voltage	0.6/1 kV (600/1000V)
Max. permissible operating voltage AC	0.7/1.2 kV
Max. permissible operating voltage DC	0.9/1.8 kV
AC Test Voltage	3.5 kV (5 Min.)
Data transmission	With special bus elements: ASI-Bus, Profibus or use of fibre optics elements for trouble-free data transmission.
Current Carrying Capacity description	According to DIN VDE 0298, Part 4

#### Chemical parameters

Resistance to oil	Acc. to DIN EN 60811-404; DIN VDE 0473-811-404, paragraph 10
Weather resistance	Unrestricted use outdoors and indoors, resistant to ozone, UV and moisture.

#### Thermal parameters

Max. permissible temperature at conductor	90 °C
Max. short circuit temperature of the conductor	250 °C
Ambient temperature for fixed installation	min -50 °C ; max +80 °C
Ambient temperature in fully flexible operation	min -40 °C ; max +80 °C

#### Mechanical parameters

Max. tensile load	Increased tensile load through additional support element
Torsional stress	Designed for best torsional properties according to the corresponding application
Min. bending radius	Acc. to DIN VDE 0298 part 3
Travel speed	Hoist: up to 160 m/min
Basket design	Dimensions depending on system (e.g. dependent on space requirements, hoisting height and speed, wind load). Recommended: basket diameter min. 30xD; basket height approx. 45xD (where D = cable diameter).

Number of cores x cross section	Part number	MLFB Number	Conductor diameter max. mm	Outer diameter min. mm	Outer diameter max. mm	Bending radius free moving min. mm	Weight (ca.) kg/km	Conductor resistance at 20°C max. Ω/km	Current carrying capacity (1) A	Short Circuit Current (conductor) kA
3GSLTOE-J control cables										
48x1	20153609	5DE5697	1.3	31.1	34.1	171	2340	19.5	18	0.14
24x2,5	20153610	5DE5625	2	29.1	32.1	161	1780	7.98	30	0.36
30x2,5	20157101	5DE5698	2	31.1	34.1	171	2260	7.98	30	0.36
36x2,5	20157102	5DE5688	2	34.5	37.5	188	2780	7.98	30	0.36
42x2,5	20157103	5DE5690	2	36.8	39.8	199	3490	7.98	30	0.36
48x2,5	20157104	5DE5660	2	41.3	44.3	222	4040	7.98	30	0.36
54x2,5	20156743	5DE5667	2	45.5	48.5	243	3890	7.98	30	0.36
24x3,5	20157105	5DE5678	2.4	32	35	175	2350	5.55	39	0.5
30x3,5	20157106	5DE5680	2.4	34.3	37.3	187	2970	5.55	39	0.5
36x3,5	20157107	5DE5681	2.4	37.9	40.9	205	3750	5.55	39	0.5
42x3,5	20157108	5DE5685	2.4	42.4	45.4	227	4510	5.55	39	0.5
7x4	20157109	5DE5668	3	18.1	20.1	101	670	4.95	41	0.57
3GSLTOE-J control cables with bus element										
24x2,5+1x(2x1)C	20167170	5DE5654	2	31.1	34.1	171	2200	7.98	30	0.36
24x2,5+4x(2x1)C	20161731	5DE5661	2	41.2	44.2	221	3600	7.98	30	0.36
36x2,5+2x(2x1)C	20161565	5DE5657	2	41.3	44.3	222	3830	7.98	30	0.36
42x2,5+2x(2x1)C	20057241	5DE5732	2	43.5	46.5	233	3600	7.98	30	0.36
3GSLTOE-J control cables with integrated FO										
24x2,5+6x(1G62,5)	20006901	5DE5747	2	35.6	38.6	193	2400	7.98	30	0.36
24x2,5+12x(1G62,5)	20166384	5DE5635	2	34.5	37.5	188	2530	7.98	30	0.36
30x2,5+6x(1G62,5)	20157411	5DE5675	2	34.5	37.5	188	2660	7.98	30	0.36
32x2,5+4x(3E9)	20160402	5DE5***	2	35.1	38.1	191	2700	7.98	30	0.36
36x2,5+6x(1G62,5)	20166382	5DE5658	2	36.8	39.8	199	3360	7.98	30	0.36
36x2,5+6x(2G62,5)	20164200	5DE5641	2	36.8	39.8	199	3360	7.98	30	0.36
36x2,5+6x(2G50)	20161440	5DE5640	2	36.8	39.8	199	3360	7.98	30	0.36
42x2,5+6x(1G62,5)	20160680	5DE5648	2	41.3	44.3	222	3910	7.98	30	0.36
42x2,5+6x(2G62,5)	20155769	5DE5650	2	41.3	44.3	222	3910	7.98	30	0.36
42x2,5+6x(2G50)	20161435	5DE5***	2	41.3	44.3	222	3910	7.98	30	0.36
42x2,5+6x(2E9)	20163163	5DE5***	2	41.3	44.3	222	3910	7.98	30	0.36
42x2,5+6x(3E9)	20158105	5DE5***	2	41.3	44.3	222	3910	7.98	30	0.36
48x2,5+6x(2G62,5)	20157110	5DE5649	2	45.5	48.5	243	3790	7.98	30	0.36
48x2,5+6x(2G50)	20156746	5DE5***	2	45.5	48.5	243	3790	7.98	30	0.36
48x2,5+6x(2E9)	20166654	5DE5642	2	45.5	48.5	243	3790	7.98	30	0.36
48x2,5+6x(3G62,5)	20160143	5DE5643	2	45.5	48.5	243	3790	7.98	30	0.36
50x2,5+4x(3G50)	20157798	5DE5***	2	45.5	48.5	243	3900	7.98	30	0.36
42x3,5+6x(1G62,5)	20162021	5DE5653	2.4	48.1	51.1	256	4150	5.55	39	0.5
3GSLTOE-O AWG control cables										
20x12AWG	20164631	5DE5694	2.4	30.2	33.3	167	1910	5.75	39	0.43
24x12AWG	20160976	5DE5695	2.4	31.6	34.6	173	2360	5.75	39	0.43
30x12AWG	20164632	5DE5693	2.4	34.4	37.4	187	2770	5.75	39	0.43
36x12AWG	20164633	5DE5696	2.4	38.1	41.1	206	3730	5.75	39	0.43
42x12AWG	20154751	5DE5692	2.4	42.4	45.4	227	4500	5.75	39	0.43

Number of cores x cross section	Part number	MLFB Number	Conductor diameter max. mm	Outer diameter min. mm	Outer diameter max. mm	Bending radius free moving min. mm	Weight (ca.) kg/km	Conductor resistance at 20°C max. Ω/km	Current carrying capacity (1) A	Short Circuit Current (conductor) kA
3GSLTOE-O AWG control cables with integrated FO										
20x12AWG +4x1LWL	20164634	5DE5676	2.4	32	35	175	2330	5.75	39	0.43
32x12AWG +4x1LWL	20164635	5DE5686	2.4	38.9	41.9	210	3740	5.75	39	0.43
36x12AWG +6x1LWL	20164636	5DE5671	2.4	43.4	46.4	232	4740	5.75	39	0.43
38x12AWG +4x(1G62,5)	20162022	5DE5673	2.4	42.4	45.4	227	4370	5.75	39	0.43
38x12AWG +4x3LWL	20164637	5DE5699	2.4	42.4	45.4	227	4370	5.75	39	0.43

(1) Nominal current carrying capacity for rubber cables laid on a surface, at 30°C ambient temperature (see also VDE 0298-4, Table 15). Special designs upon request!





# Crane cables



# ROUND LOW VOLTAGE CABLES FOR FESTOON OPERATION

	<b>RONDOFLEX</b>	<b>RONDOFLEX(C) -FC</b>	<b>FESTOONFLEX PUR HF</b>	<b>FESTOONFLEX C PUR HF</b>
Designation	(N)GRDGOEU Rubber	(N)GRDGCGOEU Rubber	D12Y11Y	D12YC11Y
Dimension	Optimized on DIN VDE 0250 part 814	Optimized on DIN VDE 0250 part 814	Optimized	Optimized
Cores	Power: 1C, 3C+3G, 4C, 5C Control: multicores (also with BUS of TSP)	Power: 3C+3G, 4C with overall CU screen	Power: 1C, 3C, 4C, 5C Control: multicores	Power: 1C, 3C, 4C, 5C Control: multicores with overall CU screen (also with BUS of TSP)
Outer Sheath	Rubber	Rubber	PUR	PUR
Approvals	VDE, GOST-R	VDE, GOST-R		
Tensile Load	15 N/mm <sup>2</sup>	15 N/mm <sup>2</sup>	15 N/mm <sup>2</sup>	15 Nmm <sup>2</sup>
Speed	240 m/min	240 m/min	210m/min	210 m/min
Temp. (moving)	-35°C/+80°C	-35°C/+80°C	-40°C/+80°C	-40°C/+80°C

## RONDOFLEX (N)GRDG0EU

### Low voltage round cable for festoon application



#### Application

Flexible low voltage power and control cable, for use on festoon systems and for connecting movable parts of machine tools, material handling equipment, etc. Suitable for application under high mechanical stresses and frequent bending during operation.

#### Global data

Brand	RONDOFLEX
Type designation	(N)GRDG0EU-J/-O
Standard	Based on DIN VDE 0250-814
Certifications / Approvals	VDE Reg. Nr. 7841; GOST-R

#### Design features

Conductor	Bare electrolytic copper, finely stranded, class 5
Insulation	PROTOLON MS High grade special compound based on high-quality EPR (at least GI3); improved mechanical and electrical characteristics
Core identification	Best identification as a result of light colored insulation with numbers printed in black for power and control cables, earth conductor green/ yellow (acc. to DIN VDE 0293)
Individual screen	Braid screen made of tinned copper wires, transfer impedance optimized at 30 MHz. Surface covered: at least 60% for individually shielded cores; at least 80% for twisted and shielded pairs
Core arrangement	Laid-up in a maximum of 3 layers
Inner sheath	Basic material EPR, Rubber compound GM1b Colour: black
Outer sheath	High grade special compound (at least 5GM3), based on PCP; Color: black
Marking	RONDOFLEX (N)GRDG0EU-J/-O VDE-Reg.-No.

#### Electrical parameters

Rated voltage	0.6/1 kV (600/1000V)
Max. permissible operating voltage AC	0.7/1.2 kV
Max. permissible operating voltage DC	0.9/1.8 kV
AC Test Voltage	3.5 kV (5 Min.)
Current Carrying Capacity description	Acc. to DIN VDE 0298-4: - single core, table 15-column 2 - multicore, table 15-column 4

#### Chemical parameters

Resistance to oil	Acc. to DIN EN 60811-404 and DIN VDE 0473-811-404, paragraph 10
Weather resistance	Unrestricted use outdoors and indoors, resistant to ozone, UV and moisture

#### Thermal parameters

Max. permissible temperature at conductor	90 °C
Max. short circuit temperature of the conductor	250 °C
Ambient temperature for fixed installation	min -50 °C ; max +80 °C
Ambient temperature in fully flexible operation	min -35 °C ; max +80 °C

#### Mechanical parameters

Max. tensile load on the conductor	15 N/mm <sup>2</sup>
Torsional stress	± 25 °/m
Min. bending radius	Acc. to DIN VDE 0298 part 3
Min. distance with S-type directional changes	20 x D
Travel speed	- Trolley (festoon system): up to 240 m/min (it is recommended to consult the manufacturer for speeds beyond 240 m/min); - Reeling operation: 60 m/min.
Additional tests	Bending test

Number of cores x cross section	Part number	MLFB Number	Conductor diameter max. mm	Outer diameter min. mm	Outer diameter max. mm	Bending radius free moving min. mm	Weight (ca.) kg/km	Permissible tensile force max. N	Conductor resistance at 20°C max. Ω/km	Current carrying capacity for install. free in air (2) A	Short Circuit Current (conductor) kA
(N)GRDG0EU-O power cables, single-core design											
1x25	20003532	5DG6610	6.7	11.4	12.6	63	330	370	0.78	138	3.58
1x35	20003533	5DG6611	8	12.3	13.9	70	430	520	0.55	170	5.01
1x50	20003534	5DG6612	9.5	15	16.6	83	620	750	0.39	212	7.15
1x70	20003535	5DG6613	11	16.3	18.3	92	830	1050	0.27	263	10.01
1x95	20003536	5DG6614	12.8	18.5	20.5	103	1070	1420	0.21	316	13.59
1x120	20003537	5DG6615	14.4	20.3	22.3	112	1330	1800	0.16	370	17.16
1x150	20003538	5DG6616	16.4	22.7	24.7	124	1640	2250	0.13	424	21.45
1x185	20003539	5DG6617	17.8	24.6	27.6	138	2010	2770	0.11	484	26.46
1x240	20003540	5DG6618	20.9	28.9	31.9	160	2650	3600	0.08	567	34.32
(N)GRDG0EU-J power cables, 3-core design, earth conductor splitted into three parts											
3x35+3x16/3	20003544	5DG6631	8	27.3	30.3	152	1780	1570	0.55	170	5.01
3x50+3x25/3	20003545	5DG6632	9.5	33	36	180	2570	2250	0.39	212	7.15
3x70+3x35/3	20003546	5DG6633	11	38.9	41.9	210	3570	3150	0.27	263	10.01
(N)GRDG0EU-J power cables, 4-core design											
4x4	20003550	5DG6642	2.5	13.6	15.2	76	350	240	4.95	43	0.57
4x6	20003551	5DG6643	3	15.9	17.9	90	480	360	3.3	56	0.86
4x10	20003552	5DG6644	4	18	20	100	680	600	1.91	78	1.43
4x16	20003553	5DG6645	5.7	23.3	25.3	127	1110	960	1.21	104	2.29
4x25	20003554	5DG6646	6.8	26.9	29.9	150	1610	1500	0.78	138	3.58
4x35	20003555	5DG6647	8.1	30.1	33.1	166	2100	2100	0.55	170	5.01
4x50	20003556	5DG6648	9.6	36.1	39.1	196	3010	3000	0.39	212	7.15
(N)GRDG0EU-J power cables, 5-core design											
5x4	20003559	5DG6652	2.5	15.7	17.7	89	450	300	4.95	43	0.57
5x6	20003560	5DG6653	3	17.5	19.5	98	580	450	3.3	56	0.86
5x10	20003561	5DG6654	4	20.2	22.2	111	860	750	1.91	78	1.43
5x16	20003562	5DG6655	5.7	24.5	27.5	138	1340	1200	1.21	104	2.29
5x25	20003563	5DG6656	6.8	29.9	32.9	165	1990	1870	0.78	138	3.58
5x35	20003564	5DG6657	8.1	34.7	37.7	189	2700	2620	0.55	170	5.01
(N)GRDG0EU-J control cables											
12x1,5	20003568	5DG6662	1.6	16.2	18.2	91	460	270	13.3	24	0.21
18x1,5	20003569	5DG6663	1.6	18.7	20.7	104	630	400	13.3	24	0.21
24x1,5	20003570	5DG6664	1.6	22.1	24.1	121	840	540	13.3	24	0.21
30x1,5	20003571	5DG6665	1.6	23.3	25.3	127	950	670	13.3	24	0.21
36x1,5		5DG6666	1.6	24.6	27.6	138	1090	810	13.3	24	0.21
4x2,5	20003549	5DG6641	2	11.8	13.4	67	250	150	7.98	32	0.36
7x2,5	20003574	5DG6671	2	15.3	17.4	87	430	260	7.98	32	0.36
12x2,5	20003575	5DG6672	2	18	20	100	600	450	7.98	32	0.36
18x2,5	20003576	5DG6673	2	21.5	23.5	118	870	670	7.98	32	0.36
24x2,5	20003577	5DG6674	2	24	27	135	1140	900	7.98	32	0.36

Number of cores x cross section	Part number	MLFB Number	Conductor diameter max. mm	Outer diameter min. mm	Outer diameter max. mm	Bending radius free moving min. mm	Weight (ca.) kg/km	Permissible tensile force max. N	Conductor resistance at 20°C max. Ω/km	Current carrying capacity for install. free in air (2) A	Short Circuit Current (conductor) kA
30x2,5	20003578	5DG6675	2	26.4	29.4	147	1360	1120	7.98	32	0.36
36x2,5	20003579	5DG6676	2	28.7	31.7	159	1550	1350	7.98	32	0.36
24x3,5		5DG6912	2.4	34.6	37.6	188	2160	1260	5.55	41	0.5
30x3,5		5DG6911	2.4	36.4	39.4	197	2450	1570	5.55	41	0.5
(N)GRDG0EU-O bus cables											
3x(2x1)C	20003590	5DG6689	1.3	20.8	22.8	114	690	90	19.5	19	0.14
6x(2x0,5)C	20003593	5DG6693	0.9	21.6	24.6	123	800	90	39	11	0.07
6x(2x1)C	20003594	5DG6694	1.3	27	30.2	151	1230	180	19.5	19	0.14
9x(2x0,5)C		5DG6691	0.9	28.3	31.3	157	1340	130	39	11	0.07
9x(2x1)C	20003592	5DG6692	1.3	35.3	38.3	192	1930	270	19.5	19	0.14
12x(2x0,5)C		5DG6521	0.9	29.8	32.8	164	1540	180	39	11	0.07
12x(2x1)C	20038334	5DG6696	1.3	36.3	39.3	197	2020	360	19.5	19	0.14
12x1(C)	20003582	5DG6681	1.3	17.6	19.6	98	540	180	19.5	19	0.14

(2) Nominal current carrying capacity for rubber cables installed free in air, at 30°C ambient temperature (see also technical annexes).



## RONDOFLEX(C)-FC (N)GRDGCGOEU

### Low voltage screened round cable for festoon application



#### Application

For use on festoon systems, e.g. on gantry cranes, hall gantry cranes, rack material handling equipment, transportation systems or machine tools. Especially suitable where power cables are expected to cause interference and disruption on data cables or where the maximum emission values according to EN 55011/55022 must be achieved.

The cables are used under high mechanical stresses and frequent bending. Also suitable for use as flexible motor power supply cable.

#### Global data

Brand	RONDOFLEX(C)-FC
Type designation	(N)GRDGCGOEU-J
Standard	Based on DIN VDE 0250-814
Certifications / Approvals	VDE Reg. Nr. 7841; GOST-R

#### Notes on installation

Notes on installation	Due to external damages a short circuit current can occur between phase conductor and the screen or between a phase conductor and a protective conductor. In these cases only the cross-section of the screen or the cross-section of the protective conductor is available to carry the fault current. The effective resistance of the screen or protective conductor is given by the distance between the point of the fault and the ground connection.
Notes on installation	Especially for festoon application it is not recommended the use of cross-sections beyond 3x50mm <sup>2</sup> .

#### Design features

Conductor	Bare electrolytic copper conductor, finely stranded, class 5. Earth conductor made of tinned, extremely finely stranded copper, class FS (better than class 5).
Insulation	PROTOLON MS high grade special compound based on high-quality EPR (at least GI3); improved mechanical and electrical characteristics
Core identification	Light colored insulation with numbers printed in black for power and control cables, earth conductor green/ yellow
Core arrangement	Up to 10mm <sup>2</sup> : 4-core design; from 16mm <sup>2</sup> on: three main conductors, earth conductor splitted into three parts and placed into the interstices
Inner sheath	Basic material EPR, compound type GM1b, color: black
Screen over inner sheath	Braid screen made of tinned copper wires, surface covered: >80%, transfer impedance <100mΩ/m at <= 30MHz
Outer sheath	Basic material PCP, rubber compound 5GM3, colour: black
Marking	RONDOFLEX (C)-FC (N)GRDGCGÖU-J (nr. of cores)x(cross section) 0,6/1 kV VDE-Reg.-Nr. 7841

#### Electrical parameters

Rated voltage	0.6/1 kV (600/1000V)
Max. permissible operating voltage AC	0.7/1.2 kV
Max. permissible operating voltage DC	0.9/1.8 kV
AC Test Voltage	5 kV (5 Min.)
Peak voltage	2400 V
Max. AC voltage for connection on frequency converter	690 V
EMC	Main application thanks to the special cable design
Current Carrying Capacity description	Acc. to DIN VDE 0298-4

#### Chemical parameters

Resistance to oil	Acc. to DIN EN 60811-404 and DIN VDE 0473-811-404, paragraph 10
Weather resistance	Unrestricted use outdoors and indoors, resistant to ozone, UV and moisture

#### Thermal parameters

Max. permissible temperature at conductor	90 °C
Max. short circuit temperature of the conductor	250 °C
Ambient temperature for fixed installation	min -50 °C ; max +80 °C
Ambient temperature in fully flexible operation	min -35 °C ; max +80 °C

### Mechanical parameters

Max. tensile load on the conductor	15 N/mm <sup>2</sup>
Torsional stress	Not allowed
Min. bending radius	Acc. to DIN VDE 0298 part 3
Travel speed	- Trolley (festoon system): up to 240m/min Note: the trouble free operation is influenced by a number of factors (e.g. space, cable weight, loop length, number of motor driven carriers). It is recommended to consult the cable manufacturer for travel speeds beyond 240 m/min.
Additional tests	Bending test

Number of cores x cross section	Part number	MLFB Number	Conductor diameter max. mm	Outer diameter min. mm	Outer diameter max. mm	Bending radius free moving min. mm	Weight (ca.) kg/km	Nom. operating capacitance µF/km	Inductance nom. mH/km	Current carrying capacity for install. free in air (2) A	Transfer impedance at 1 MHz mΩ/m	Transfer impedance at 10 MHz mΩ/m	Transfer impedance at 30 MHz mΩ/m
(N)GRDGCGOEU-J screened power cables													
4x2,5	20007109	5DG6651	2	13	15	75	340	0.17	0.58	32			
4x4	20003583	5DG6682	2.5	14.8	17.8	89	480	0.18	0.55	43			
4x6	20003584	5DG6683	3	16.2	19.2	96	640	0.19	0.53	56			
4x10	20003585	5DG6684	4	19.6	22.6	113	890	0.23	0.51	78	0.4	1.3	3.5
3x16+3x2,5	20003586	5DG6685	5.7	22.4	25.4	127	1150	0.225	0.48	104	0.2	0.6	1.5
3x25+3x4	20003587	5DG6686	6.8	25.4	28.4	142	1590	0.275	0.45	138	0.2	0.4	1.3
3x35+3x6	20003588	5DG6687	8.1	29.3	32.3	162	2160	0.325	0.43	170	0.1	0.4	0.9
3x50+3x10	20003589	5DG6688	9.6	35.4	38.4	192	3060	0.4	0.41	212	0.1	0.2	0.7
3x70+3x10	20003591	5DG6690	11.5	40.8	43.8	219	3960	0.475	0.39	263	0.1	0.2	0.5
3x95+3x16	20003580	5DG6679	12.9	43.4	46.4	232	4840	0.6	0.375	316	0.1	0.2	0.4
3x120+3x16	20003581	5DG6680	14.6	47.8	50.8	254	5910	0.7	0.36	370	0.1	0.1	0.3
3x150+3x25	20003558	5DG6650	16.5	54.6	57.6	288	7540			424			

(2) Nominal current carrying capacity for rubber cables installed free in air, at 30°C ambient temperature (see also technical appendixes). Especially for festoon application it is not recommended the use of cross-sections beyond 3x50mm<sup>2</sup>!



## FESTOONFLEX PUR-HF D12Y11Y

Low voltage round cable PUR sheathed for festoon application



### Application

For use as energy and control cable in festoon systems under severe conditions, incl. frequent bending. Also for drag lines, machine tools or materials handling systems.

In addition, suitable as drum reeling cable under moderate mechanical stress.

### Global data

Brand	FESTOONFLEX PUR-HF
Type designation	D12Y11Y-J/O

### Design features

Conductor	Plain copper, flexible class 5 acc. to DIN EN 60228 / DIN VDE 0295
Insulation	Halogen free compound, based on polyester
Core identification	Up to 5 cores: colored in accordance with DIN VDE 0293-308; From 6 cores: white with black numbers
Core arrangement	Cores twisted with short length of lay around central element
Outer sheath	Polyurethane, halogen free, flame retardant; Colour: black (opaque)
Marking	White imprint: FESTOONFLEX PUR-HF -J/-O (number of cores) x (cross-section) (year/week)

### Electrical parameters

Rated voltage	0.6/1 kV (600/1000V)
Max. permissible operating voltage AC	0.7/1.2 kV
Max. permissible operating voltage DC	0.9/1.8 kV
AC Test Voltage	4 kV (5 Min.)
Current Carrying Capacity description	Acc. to DIN VDE 0298-4

### Chemical parameters

Resistance to fire	Similar to IEC 60332-1
Water resistance	The cables are suitable for permanent use in water (no drinking water) up to 50 meter diving depth.

### Thermal parameters

Max. permissible temperature at conductor	90 °C
Max. short circuit temperature of the conductor	250 °C
Ambient temperature for fixed installation	min -50 °C ; max +80 °C
Ambient temperature in fully flexible operation	min -40 °C ; max +80 °C

### Mechanical parameters

Max. tensile load on the conductor	15 N/mm <sup>2</sup>
Torsional stress	± 25 °/m
Min. bending radius	6 x D (Proved by flexing tests acc. to HD 22.2 part 3.1)
Travel speed	- In festoon systems: up to 210 m/min; - For reeling operation: up to 60 m/min; - In chain systems: up to 210 m/min (note: trouble free operation is influenced by several factors, among all the chain length. For long chain system we recommend to operate at lower speed).

Number of cores x cross section	Part number	Conductor diameter max. mm	Outer diameter min. mm	Outer diameter max. mm	Bending radius free moving min. mm	Weight (ca.) kg/km	Permissible tensile force max. N	Conductor resistance at 20°C max. Ω/km	Current carrying capacity for install. free in air (2) A	Short Circuit Current (conductor) kA
D12Y11Y-O power cables, single core										
1x16	20165443	5	8.5	9.5	57	170	240	1.21	104	2.29
1x25	20156874	6.2	9.9	11.1	67	270	370	0.78	138	3.58
1x35	20154575	7.8	11.7	12.9	77	380	520	0.55	170	5.01
1x50	20154574	8.9	13.9	15.1	91	530	750	0.39	212	7.15
1x70	20154573	11.1	16.2	17.4	104	740	1050	0.27	263	10.01
1x95	20166593	12.6	17.9	19.1	115	940	1420	0.21	316	13.59
1x120	20156873	14.8	20.2	21.5	130	1200	1800	0.16	370	17.16
1x150		16	21.8	23.2	139	1490	2250	0.13	424	21.45
1x185		17.7	24.3	25.7	154	1830	2770	0.11	484	26.46
1x240		20.2	27.7	29.3	176	2300	3600	0.08	567	34.32
1x300		22.7	30	32	192	3200	4500	0.06	651	42.9
D12Y11Y-O power cables, three core										
3x1,5		1.5	6.5	7.5	45	115	60	13.3	24	0.21
3x2,5	20156877	2	8.5	9.5	57	130	110	7.98	32	0.36
D12Y11Y-J power cables, four core										
4x1,5		1.5	8.1	9.1	55	120	90	13.3	24	0.21
4x2,5	20156878	2	9.2	10.2	61	160	150	7.98	32	0.36
4x4	20160347	2.6	10.3	11.5	69	230	240	4.95	43	0.57
4x6		3.2	12.1	13.2	80	320	360	3.3	56	0.86
4x10	20154577	4	15	16.2	97	520	600	1.91	78	1.43
4x16	20156879	5	17.7	18.9	113	750	960	1.21	104	2.29
4x25	20160348	6.2	21.1	22.5	135	1160	1500	0.78	138	3.58
4x35		7.8	25.8	27.4	164	1650	2100	0.55	170	5.01
4x50		9.6	31	33	198	2410	3000	0.39	212	7.15
4x70		11.1	38.1	40.6	244	3070	4200	0.27	263	10.01
4x95		12.6	42.0	44.5	267	4150	5700	0.21	316	13.59
D12Y11Y-J power cables, five core										
5x1,5		1.5	8	9	54	150	110	13.3	24	0.21
5x2,5		2	9.8	11	66	180	180	7.98	32	0.36
5x4	20154579	2.6	11.6	12.7	77	290	300	4.95	43	0.57
5x6	20154578	3.2	14	15.2	91	420	450	3.3	56	0.86
5x10		4	16.2	17.5	105	630	750	1.91	78	1.43
5x16	20166492	5	19.4	20.6	124	920	1200	1.21	104	2.29
5x25		6.2	23.2	24.5	148	1380	1870	0.78	138	3.58
D12Y11Y-J Control cables										
7x1,5		1.5	9	10	60	220	150	13.3	24	0.21
12x1,5		1.5	14.3	15.5	93	320	270	13.3	24	0.21
18x1,5	20154580	1.5	14.5	15.7	94	380	400	13.3	24	0.21
24x1,5	20157942	1.5	16.5	17.8	107	500	540	13.3	24	0.21
30x1,5		1.5	19.6	21	126	680	670	13.3	24	0.21
36x1,5		1.5	21.1	22.5	135	770	810	13.3	24	0.21
7x2,5	20166594	2	11.5	12.7	76	250	260	7.98	32	0.36
12x2,5	20160349	2	16.5	17.7	106	460	450	7.98	32	0.36

Number of cores x cross section	Part number	Conductor diameter max. mm	Outer diameter min. mm	Outer diameter max. mm	Bending radius free moving min. mm	Weight (ca.) kg/km	Permissible tensile force max. N	Conductor resistance at 20°C max. Ω/km	Current carrying capacity for install. free in air (2) A	Short Circuit Current (conductor) kA
18x2,5	20149380	2	16.7	17.9	107	580	670	7.98	32	0.36
24x2,5	20149192	2	19.2	20.4	122	760	900	7.98	32	0.36
30x2,5		2	24.9	26.5	159	1080	1120	7.98	32	0.36
36x2,5		2	25.9	27.5	165	1300	1350	7.98	32	0.36

(2) Nominal current carrying capacity for rubber cables installed free in air, at 30°C ambient temperature (see also technical annexes). For articles without part number the values shown are approximate, and need to be confirmed in case of order.



## FESTOONFLEX C-PUR-HF D12YC11Y

Low voltage screened round cable PUR sheathed for festoon application



### Application

For use as energy and control cable in festoon systems under severe conditions, incl. frequent bending. Also for drag lines, machine tools or materials handling systems.

### Global data

Brand	FESTOONFLEX C PUR-HF
Type designation	D12YC11Y-J/O

### Design features

Conductor	Plain copper, flexible class 5 acc. to DIN EN 60228 / DIN VDE 0295
Insulation	Halogen free compound, based on polyester
Core identification	Up to 5 cores: colored in accordance with DIN VDE 0293-308 From 6 cores: natural color with black numbers
Core arrangement	Cores/Pairs twisted with short length of lay around central element
Inner sheath	Due to technical reasons some of the cross section are produced with an additional polyurethane inner sheath
Screen over inner sheath	Braid of tinned copper wires
Outer sheath	Polyurethane, halogen free, flame retardant; Colour: black (opaque).
Marking	White imprint: FESTOONFLEX C-PUR-HF -J/-O (number of cores) x (cross-section) (year/week)

### Electrical parameters

Rated voltage	0.6/1 kV (600/1000V)
Max. permissible operating voltage AC	0.7/1.2 kV
Max. permissible operating voltage DC	0.9/1.8 kV
AC Test Voltage	4 kV (5 Min.)
Current Carrying Capacity description	Acc. to DIN VDE 0298-4

### Chemical parameters

Resistance to fire	Similar to IEC 60332-1
Water resistance	The cables are suitable for permanent use in water (no drinking water) up to 50 meter diving depth.

### Thermal parameters

Max. permissible temperature at conductor	90 °C
Max. short circuit temperature of the conductor	250 °C
Ambient temperature for fixed installation	min -50 °C ; max +80 °C
Ambient temperature in fully flexible operation	min -40 °C ; max +80 °C

### Mechanical parameters

Max. tensile load on the conductor	15 N/mm <sup>2</sup>
Torsional stress	Not allowed
Min. bending radius	6 x D (Proved by flexing tests acc. to HD 22.2 part 3.1)
Travel speed	- In festoon systems: up to 210 m/min; - In chain systems: up to 210 m/min (note: trouble free operation is influenced by several factors, among all the chain length. For long chain system we recommend to operate at lower speed).

Number of cores x cross section	Part number	Conductor diameter max. mm	Outer diameter min. mm	Outer diameter max. mm	Bending radius free moving min. mm	Weight (ca.) kg/km	Permissible tensile force max. N	Conductor resistance at 20°C max. Ω/km	Current carrying capacity for install. free in air (2) A	Short Circuit Current (conductor) kA
D12YC11Y-O screened power cables, single core										
1x25		6.2	10.3	11.5	69	330	370	0.78	138	3.58
1x35	20161370	7.8	12.3	13.5	81	430	520	0.55	170	5.01
1x50		8.9	15.4	16.6	100	610	750	0.39	212	7.15
1x70	20157795	11.1	17.0	18.3	110	810	1050	0.27	263	10.01
1x95		12.6	18.9	20.1	121	1030	1420	0.21	316	13.59
1x120	20156875	14.8	21.4	22.8	137	1320	1800	0.16	370	17.16
1x150		16	23.1	24.5	147	1650	2250	0.13	424	21.45
1x185		17.7	25.5	27.2	163	2000	2770	0.11	484	26.46
1x240		20.2	28.5	30.1	181	2490	3600	0.08	567	34.32
D12YC11Y-J screened power cables, four core										
4x1,5		1.5	10.8	12	72	240	90	13.3	24	0.21
4x2,5	20166386	2	12.1	13.2	80	250	150	7.98	32	0.36
4x4		2.6	13.6	14.7	89	330	240	4.95	43	0.57
4x6	20161501	3.2	15.1	16.3	98	420	360	3.3	56	0.86
4x10		4	18.4	19.6	118	640	600	1.91	78	1.43
4x16	20166385	5	21.2	22.5	136	940	960	1.21	104	2.29
4x25		6.2	24.5	26.2	157	1360	1500	0.78	138	3.58
4x35	20168451	7.8	29.6	31.6	190	1870	2100	0.55	170	5.01
4x50		9.6	35.1	37.6	226	2560	3000	0.39	212	7.15
D12YC11Y-J screened power cables, five core										
5x1,5		1.5	10.9	12.1	73	250	110	13.3	24	0.21
5x2,5		2	12.8	14	84	280	180	7.98	32	0.36
5x4		2.6	13.8	15	90	345	300	4.95	43	0.57
D12YC11Y-J screened control cables										
7x1,5	20166387	1.5	10.9	12.1	73	220	150	13.3	24	0.21
12x1,5	20156247	1.5	15	16.2	97	360	270	13.3	24	0.21
18x1,5	20157796	1.5	15	16.2	97	420	400	13.3	24	0.21
12x2,5		2	17.4	18.6	112	530	450	7.98	32	0.36
18x2,5		2	17.5	18.8	113	650	670	7.98	32	0.36
D12YC11Y-O overall screened control pairs										
3x(2x1,5)		1.5	16.5	17.8	107	350	130	13.3	24	0.21
4x(2x1)		1.3	15.3	16.5	99	310	120	19.5	19	0.14
4x(2x1,5)		1.5	17.2	18.5	111	385	180	13.3	24	0.21
D12Y11Y-O individually screened control pairs										
4x(2x1)C	20161461	1.3	15.9	17.1	103	350	120	19.5	19	0.14
6x(2x1)C	20160120	1.3	19.0	20.3	122	480	180	19.5	19	0.14
9x(2x1)C		1.3	23.6	25	150	721	270	19.5	19	0.14
2x(2x1,5)C		1.5	15.2	16.4	98	280	90	13.3	24	0.21

Number of cores x cross section	Part number	Conductor diameter max. mm	Outer diameter min. mm	Outer diameter max. mm	Bending radius free moving min. mm	Weight (ca.) kg/km	Permissible tensile force max. N	Conductor resistance at 20°C max. Ω/km	Current carrying capacity for install. free in air (2) A	Short Circuit Current (conductor) kA
2x(2x2,5)C		2	17.2	18.5	111	340	150	7.98	32	0.36
3x(2x1,5)C	20156880	1.5	17.2	18.5	111	350	130	13.3	24	0.21
3x(2x2,5)C		2	17.5	18.8	113	390	220	7.98	32	0.36

(2) Nominal current carrying capacity for rubber cables installed free in air, at 30°C ambient temperature (see also technical annexes). For articles without part number the values shown are approximate, and need to be confirmed in case of order.





# Crane cables



# FLAT LOW VOLTAGE CABLES FOR FESTOON OPERATION

	PLANOFLEX	M(StD)HOEU
Designation	NGFLGOEU	M(StD)HOEU
Dimension	DIN VDE 0250 part 809	Similar to DIN VDE 0250 part 809
Cores	Power: 4C, 5C, 7C Control: multicore (also with IS and TSP)	Power: 4C Control: multicore (also with TSP)
Outer Sheath	Rubber	Rubber
Approvals	VDE, GOST-R, UL-File E 113313	VDE, UL AWM Style 4540
Tensile Load	15 N/mm <sup>2</sup>	15 N/mm <sup>2</sup>
Speed	180 m/min	180 m/min
Temp. (moving)	-35°C/+80°C	-30°C/+80°C

## PLANOFLEX NGFLGOEU

### Low voltage flat cable for festoon application



#### Application

Flexible low voltage power and control cable, for use on festoon systems and for connecting moveable parts of machine tools, material handling equipment, etc., associated with high mechanical stresses and frequent bending during operation and for bending in one plane only.

#### Global data

Brand	PLANOFLEX
Type designation	NGFLGOEU-J/-O
Standard	DIN VDE 0250-809
Certifications / Approvals	VDE Marking; UL-File E 113313; GOST-R

#### Design features

Conductor	Electrolytic copper, not tinned: - up to 25 mm <sup>2</sup> : extremely finely stranded, class 6 - above 35 mm <sup>2</sup> : finely stranded, class 5
Insulation	PROTOLON
Core identification	Basic material EPR, Rubber compound 3GI3 (refer also to DIN VDE 0207, Part 20) Up to 5 cores, colored: green/yellow (or black for version...-O) black, blue, brown, grey; For more than 5 cores: black with white colored numbers
Individual screen	Braid screen made of tinned copper wires, transfer impedance optimized at 30 MHz. Surface covered: approx. 60% for shielded cores, approx. 80% for twisted and shielded pairs.
Core arrangement	Parallel, for more than 12 cores: parallel bundles
Outer sheath	Basic material CR, Rubber compound 5GM3 (refer also to DIN VDE 0207, Part 21) Colour: black
Marking	<VDE>PLANOFLEX NGFLGOEU-J/-O (number of cores)x(cross-section) 600V, 90°C, (UL), PLANOFLEX (cross-section) AWG/(number of cores)(type of core) OUTDOOR

#### Electrical parameters

Rated voltage	300/500V (600V)
Max. permissible operating voltage AC	0.7/1.2 kV
Max. permissible operating voltage DC	0.9/1.8 kV
AC Test Voltage	2.5 kV (5 Min.)
Current Carrying Capacity description	Acc. to DIN VDE 0298-4

#### Chemical parameters

Resistance to oil	Acc. to DIN VDE 0473-404, paragraph 10
Weather resistance	Unrestricted use outdoors and indoors, resistant to ozone, UV and moisture.

#### Thermal parameters

Max. permissible temperature at conductor	90 °C
Max. short circuit temperature of the conductor	250 °C
Ambient temperature for fixed installation	min -50 °C ; max +80 °C
Ambient temperature in fully flexible operation	min -35 °C ; max +80 °C

#### Mechanical parameters

Max. tensile load on the conductor	15 N/mm <sup>2</sup>
Torsional stress	Not allowed
Min. bending radius	Acc. to DIN VDE 0298 part 3
Travel speed	- Gantry (reeling operation): no application; - Trolley (festoon system): guidance value up to 180m/min (it is recommended to consult the manufacturer for speeds beyond 180m/min).
Additional tests	Bending test

Number of cores x cross section	Part number	MLFB Number	Conductor diameter max. mm	Min. Height (for flat cable) mm	Max. Height (for flat cable) mm	Min. Width (for flat cable) mm	Max. Width (for flat cable) mm	Bending radius free moving min. mm	Weight (ca.) kg/km	Permissible tensile force max. N	Conductor resistance at 20°C max. Ω/km	Current carrying capacity for install. free in air (2) A	Short Circuit Current (conductor) kA
NGFLGOEU-J control cables													
3x1,5		5DG5751	1.5	5.7	6.2	11.7	12.5	19	130	68	13.3	24	0.21
4x1,5	20003476	5DG5711	1.5	5.7	6.2	15	15.8	19	170	90	13.3	24	0.21
5x1,5		5DG5712	1.5	5.5	6	18.5	20.1	18	210	113	13.3	24	0.21
7x1,5		5DG5714	1.5	5.5	6	25	26.8	18	280	158	13.3	24	0.21
8x1,5	20003480	5DG5715	1.5	5.5	6	27.5	29.3	18	310	180	13.3	24	0.21
10x1,5		5DG5717	1.5	6.2	6.7	35.5	37	20	440	225	13.3	24	0.21
12x1,5	20003483	5DG5718	1.5	6.3	6.8	42	43.5	20	530	270	13.3	24	0.21
24x1,5	20003485	5DG5720	1.5	11.5	12.3	51	53.2	62	1040	540	13.3	24	0.21
42x1,5	20003470	5DG5653	1.5	15.1	16.1	70.2	72.3	81	1920	945	13.3	24	0.21
4x2,5	20003487	5DG5721	2	6.8	7.3	18.5	19.5	22	260	150	7.98	32	0.36
5x2,5		5DG5722	2	6.6	7.4	22.9	24.6	22	320	188	7.98	32	0.36
7x2,5	20003490	5DG5724	2	6.8	7.4	31	32.8	22	440	263	7.98	32	0.36
8x2,5	20003492	5DG5725	2	6.8	7.4	34.1	35.9	22	490	300	7.98	32	0.36
10x2,5		5DG5727	2	7.4	8	43	45.3	24	660	375	7.98	32	0.36
12x2,5	20003494	5DG5728	2	7.4	8	50.6	53.5	24	780	450	7.98	32	0.36
24x2,5	20003496	5DG5730	2	14.8	15.6	65.4	68	78	1690	900	7.98	32	0.36
7x(3x1)	20037062	5DG5483	1.3	8.7	10.3	49.3	51.8	41	770	315	19.5	19	0.14
NGFLGOEU-J power cables													
4x4	20003498	5DG5731	2.8	8.4	8.9	22.5	23.5	36	390	240	4.95	43	0.57
4x6	20003503	5DG5741	3.5	9	9.5	25.4	26.9	38	500	360	3.3	56	0.86
4x10	20003509	5DG5765	4.5	10.5	11	30.1	32.6	44	750	600	1.91	78	1.43
4x16	20003511	5DG5766	5.6	12.1	12.9	36	37.5	65	1060	960	1.21	104	2.29
4x25	20003513	5DG5767	6.6	13.6	14.4	41.9	43.4	72	1500	1500	0.78	138	3.58
4x35	20003515	5DG5768	8.1	14.8	16.7	47	49.9	84	2040	2100	0.55	170	5.01
4x50	20003517	5DG5770	9.5	18	19	56	58	95	2830	3000	0.39	212	7.15
4x70	20003519	5DG5771	11.1	20.3	21.3	63.2	65.2	107	3820	4200	0.27	263	10.01
4x95	20003521	5DG5772	12.9	23.1	24.1	72.6	74.6	121	4930	5700	0.21	316	13.59
4x120		5DG5773	15	24.2	27.2	79.2	83.2	136	6220	7200	0.16	370	17.16
5x4		5DG5732	2.8	8.5	9	28.9	31.2	36	510	300	4.95	43	0.57
5x6	20003505	5DG5742	3.5	9.1	9.6	31.8	34.1	38	640	450	3.3	56	0.86
5x10		5DG5687	4.5	10.5	11.3	39.2	41.6	45	960	750	1.91	78	1.43
5x16	20003523	5DG5776	5.6	12.2	12.7	45.1	47.6	64	1360	1200	1.21	104	2.29
7x4	20003501	5DG5734	2.8	8.4	9	38.5	40.9	36	690	420	4.95	43	0.57
7x6	20003507	5DG5744	3.5	9	9.6	42.9	45.3	38	870	630	3.3	56	0.86
7x10		5DG5865	4.5	10.5	11.3	53	55.9	45	1320	1050	1.91	78	1.43
7x16		5DG5866	5.6	12.6	13.4	60.7	63.9	67	1990	1680	1.21	104	2.29
7x25	20070764	5DG5867	6.6	14.8	15.6	72.6	75.9	78	2820	2625	0.78	138	3.58
7x35		5DG5868	8.1	16.4	17.4	83.7	87	87	3820	3675	0.55	170	5.01
(N)GFLGOEU-O control cables with individually screened cores													
12x1(C)	20003474	5DG5670	1.3	6.6	7.1	48.2	51.3	21	660	180	19.5	19	0.14
4x1,5(C)	20155763	5DG5880	1.5	6.8	7.4	18.5	19.5	22	250	90	13.3	24	0.21
8x1,5(C)		5DG5884	1.5	6.8	7.4	35.1	35.1	22	510	180	13.3	24	0.21
12x1,5(C)	20003527	5DG5888	1.5	7.4	8	51.7	55	24	780	270	13.3	24	0.21

Number of cores x cross section	Part number	MLFB Number	Conductor diameter max. mm	Min. Height (for flat cable) mm	Max. Height (for flat cable) mm	Min. Width (for flat cable) mm	Max. Width (for flat cable) mm	Bending radius free moving min. mm	Weight (ca.) kg/km	Permissible tensile force max. N	Conductor resistance at 20°C max. Ω/km	Current carrying capacity for install. free in air (2) A	Short Circuit Current (conductor) kA
(N)GFLGOEU-O bus cables													
4x(2x1)C	20003528	5DG5890	1.3	10.5	11.3	31.8	33.8	45	630	120	19.5	19	0.14
6x(2x2,5)C	20054902	5DG5898	2	14.2	15.2	60	62.7	76	1680	450	7.98	32	0.36
7x(2x1)C	20003529	5DG5893	1.3	10.5	11.3	53.1	56	45	1090	210	19.5	19	0.14
(N)GFLGOEU-J power cables with individual screen													
4x4(C)		5DG5484	2.8	9.2	10.2	26.3	29.3	41	550	240	4.95	43	0.57
4x6(C)		5DG5485	3.5	9.5	11.1	28.8	31.8	44	665	360	3.3	56	0.86
4x10(C)		5DG5486	4.5	11.7	13.3	36	39	67	1060	600	1.91	78	1.43
4x16(C)		5DG5487	5.6	12.8	14.4	40.2	43.2	72	1360	960	1.21	104	2.29
4x25(C)		5DG5488	6.6	14.8	16.8	47.3	50.3	84	1980	1500	0.78	138	3.58
4x35(C)		5DG5489	8.1	16.9	18.9	53.4	57.4	95	2590	2100	0.55	170	5.01
4x50(C)		5DG5490	9.5	19.5	21.5	62	66	108	3590	3000	0.39	212	7.15
4x70(C)		5DG5491	11.1	21.9	23.9	69.8	73.8	120	4630	4200	0.27	263	10.01
4x95(C)		5DG5492	12.9	24.2	27.2	78.7	83.7	136	5950	5700	0.21	316	13.59

(2) Nominal current carrying capacity for rubber cables installed free in air, at 30°C ambient temperature (see also technical annexes).



## M(StD)HOEU

### Low voltage screened flat cable for festoon application



#### Application

Flexible power and control cables, in particular for hoisting gears transportation systems, machine tools, at medium mechanical stresses and for severe bending in one plane only; in dry, damp, wet areas and also outdoors; where resistance against oils, fats and chemical influences is required.

#### Global data

Brand	M(StD)HOEU
Standard	UL Style 4540
Standard	Based on DIN VDE 0250-809

#### Design features

Conductor	Copper bare, up to 25 mm <sup>2</sup> : finest wire class 6 according to IEC 60228 / DIN EN 60228; 35 mm <sup>2</sup> and up: fine wire class 5 according to IEC 60228 / DIN EN 60228; Conductor wrapping: paper tape or PETP-film
Insulation	Rubber, type pf compound 3GI3 according to DIN VDE 0207-20
Core identification	Up to 5 cores: colored in accordance with DIN VDE 0293-308 From 6 cores: black with white numbers
Individual screen	ALU/PETP foil, overlapped. Spinning of tinned copper wires, covering > 85 %. Wrapping with PETP-film
Core arrangement	Cores arranged in parallel; Pair twisting: 2 Cores and 2 fillers twisted with varying direction of lay and short length of lay, wrapping with PETP-film, pairs parallel arranged
Outer sheath	Polychloroprene, type of compound 5GM3 according to DIN VDE 0207-21. Colour: black
Marking	White imprint: M(STD)HÖU-J/-O (number of cores) x (cross-section) (UL File Nr.)(UL-SZ) AWM Style 4540 90°C FT-1 600 V (week/year)

#### Electrical parameters

Rated voltage	0.6/1 kV (600/1000V)
Max. permissible operating voltage AC	0.7/1.2 kV
Max. permissible operating voltage DC	0.9/1.8 kV
AC Test Voltage	2.5 kV (5 Min.)
Current Carrying Capacity description	Acc. to VDE 0298-4

#### Thermal parameters

Max. permissible temperature at conductor	90 °C
Max. short circuit temperature of the conductor	250 °C
Ambient temperature for fixed installation	min -40 °C ; max +80 °C
Ambient temperature in fully flexible operation	min -30 °C ; max +80 °C

#### Mechanical parameters

Max. tensile load on the conductor	15 N/mm <sup>2</sup>
Torsional stress	Not allowed
Min. bending radius	Acc. to DIN VDE 0298 part 3
Travel speed	- In festoon system: up to 180m/min (it is recommended to consult the manufacturer for speeds beyond)

Number of cores x cross section	Part number	Conductor diameter max. mm	Min. Height (for flat cable) mm	Max. Height (for flat cable) mm	Min. Width (for flat cable) mm	Max. Width (for flat cable) mm	Bending radius free moving min. mm	Weight (ca.) kg/km	Permissible tensile force max. N	Conductor resistance at 20°C max. Ω/km	Current carrying capacity (1) A	Short Circuit Current (conductor) kA
M(STD)HOEU-J screened power cables, four core												
4x1,5		1.5	7	8	20.1	21.5	24	290	90	13.3	23	0.21
4x2,5		1.9	7.6	8.7	22.7	24.1	35	370	150	7.98	30	0.36
4x4		2.5	8.5	9.5	25.6	27.6	38	500	240	4.95	41	0.57
4x6		3.2	8.9	10.5	28.1	30.1	42	610	360	3.3	53	0.86
4x10		4.1	11.1	12.1	34.7	36.7	61	910	600	1.91	74	1.43
4x16		5.1	12.3	13.7	38.9	41.5	69	1320	960	1.21	99	2.29
4x25		6.4	12.5	15.5	43	47	78	1720	1500	0.78	131	3.58
4x35		7.7	14.6	17	49.8	53.2	85	2330	2100	0.55	162	5.01
4x50		9.6	17.1	19.7	58	61.6	99	3110	3000	0.39	202	7.15
4x70		11.1	22	24	73	77	120	4670	4200	0.27	250	10.01
4x95		13.1	22.7	25.3	76.3	81.9	127	5510	5700	0.21	301	13.59
M(STD)HOEU-J screened control cables												
5x1,5		1.5	7	8	23.8	25.8	24	350	110	13.3	23	0.21
8x1,5		1.5	7	8	36.2	38.6	24	550	180	13.3	23	0.21
12x1,5		1.5	7	8	52.7	57.1	24	810	270	13.3	23	0.21
4x4x1,5		1.5	10	13	36.6	42.6	65	900	360	13.3	23	0.21
6x2,5		1.9	7.6	8.7	31.5	33.5	35	530	220	7.98	30	0.36
12x2,5	20157618	1.9	7.6	8.7	60	64	35	1050	450	7.98	30	0.36
M(STD)HOEU-O individually screened control pairs												
4x(2x1)	20157617	1.3	10.2	11.8	30	33.5	47	590	120	19.5	18	0.14
7x(2x1)		1.3	10.9	12.5	55.3	59	63	1060	210	19.5	18	0.14
12x(2x1)		1.3	13.7	17	65.5	71	85	1500	360	19.5	18	0.14

(1) Nominal current carrying capacity for rubber cables laid on a surface, at 30°C ambient temperature (see also VDE 0298-4, Table 15). For articles without part number the values shown are approximate, and need to be confirmed in case of order.



# Crane cables



# LOW VOLTAGE CABLES FOR CHAIN OPERATION

	<b>RONDOFLEX (CHAIN)</b>	<b>FESTOONFLEX PUR HF</b>	<b>FESTOONFLEX C PUR HF</b>
Designation	(N)GRDGOEU-J/-0	D12Y11Y	D12YC11Y
Dimension	Optimized on DIN VDE 0250 part 814	Optimized	Optimized
Cores	Power: 1C, 3C+3G, 4C, 5C Control: multicore (also with BUS, IS or TSP)	Power: 1C, 3C, 4C, 5C Control: multicores	Power: 1C, 3C, 4C, 5C Control: multicores with overall CU screen (also with BUS of TSP)
Outer Sheath	Rubber	PUR	PUR
Approvals	VDE, GOST-R		
Tensile Load	15 N/mm <sup>2</sup>	15 N/mm <sup>2</sup>	15 N/mm <sup>2</sup>
Speed	240 m/min	210 m/min	210 m/min
Temp. (moving)	-35°C/+80°C	-40°C/+80°C	-40°C/+80°C

## RONDOFLEX(CHAIN) (N)GRDG0EU/(N)GRDGC0EU

### Low voltage cable for energy chains



#### Application

Applicable in all chain systems (e.g. container cranes, stacking cranes, indoor cranes, material handling equipment). Especially suitable in applications where, due to the outdoor installation, long travel distances or high travel speed, high performances are expected from the cable (such as long lifetime, full reliability, resistance to abrasion, etc.).

#### Global data

Brand	RONDOFLEX(CHAIN)
Type designation	(N)GRDGC0EU-J
Type designation	(N)GRDG0EU-J/-O
Standard	Based on DIN VDE 0250-814
Certifications / Approvals	GOST-R

#### Design features

Conductor	Bare electrolytic copper conductor, finely stranded, class 5. Earth conductor made of bare electrolytic copper, extremely finely stranded, class FS (better than class 5).
Insulation	PROTOLON MS High grade insulation compound based on EPR (at least 3GI3); improved mechanical and electrical performance. Alternative for control cables: ETFE.
Core identification	Light colored compound with black number prints, earth yellow-green.
Core arrangement	Up to 10 <sup>2</sup> mm: 4-core design; From 16 <sup>2</sup> mm: 3-energy cores and splitted earth conductor into three parts.
Screen	Braid screen made of tinned copper wires. Surface covered >80%, transfer impedance <100mOhm/m at <= 30MHz
Inner sheath	Special compound based on EPR (at least GM1b); color: black
Outer sheath	High grade compound based on EVA with excellent abrasion and aging performances. Color: black.
Marking	RONDOFLEX (CHAIN) (N)GRDG0EU (number of cores)x(cross section) 0,6/1 kV

#### Electrical parameters

Rated voltage	0.6/1 kV (600/1000V)
Max. permissible operating voltage AC	0.7/1.2 kV
Max. permissible operating voltage DC	0.9/1.8 kV
AC Test Voltage	3.5 kV (5 Min.)
EMC	Given thanks to the special cable design
Current Carrying Capacity description	According to DIN VDE 0298, Part 4: - single cores: table 15-section 2; - multi cores: table 15-section 4.

#### Chemical parameters

Resistance to oil	Acc. to DIN EN 60811-404 and DIN VDE 0473-811-404, paragraph 10
Weather resistance	Unrestricted use outdoors and indoors, resistant to ozone, UV and moisture

#### Thermal parameters

Max. permissible temperature at conductor	90 °C
Max. short circuit temperature of the conductor	250 °C
Ambient temperature for fixed installation	min -50 °C ; max +80 °C
Ambient temperature in fully flexible operation	min -35 °C ; max +80 °C

#### Mechanical parameters

Max. tensile load on the conductor	15 N/mm <sup>2</sup>
Torsional stress	Not allowed
Min. bending radius	Acc. to DIN VDE 0298 part 3
Travel speed	- In chain systems: up to 240 m/min (note: trouble free operation is influenced by several factors, among all the chain length. For long chain system we recommend to operate at lower speed).
Additional tests	Bending test, abrasion test, practical test on owned long-distance testing facility.

Number of cores x cross section	Part number	MLFB Number	Conductor diameter max. mm	Outer diameter min. mm	Outer diameter max. mm	Bending radius free moving min. mm	Weight (ca.) kg/km	Permissible tensile force max. N	Conductor resistance at 20°C max. Ω/km	Current carrying capacity (1) A	Short Circuit Current (conductor) kA
<b>(N)GRDGOEU-O power cables, single-core design</b>											
1x16	20003427	5DG4011	5.7	7.6	9.7	39	210	240	1.21	99	2.29
1x25	20003428	5DG4012	7.1	10.2	12.2	61	330	370	0.78	131	3.58
1x35	20168373	5DG4013	8.3	12.1	14.1	71	445	520	0.55	162	5.01
1x50	20003429	5DG4014	9.8	13.9	15.9	80	620	750	0.39	202	7.15
1x70	20003430	5DG4015	11.6	15.8	17.9	90	830	1050	0.27	250	10.01
1x95	20003431	5DG4016	13.8	19.1	21.1	106	1120	1420	0.21	301	13.59
1x120	20167027	5DG4017	14.9	20.8	22.8	114	1390	1800	0.16	352	17.16
1x150	20003432	5DG4018	17.2	23	26	130	1740	2250	0.13	404	21.45
1x185	20047699	5DG4019	18	25.2	28.2	141	2090	2770	0.11	461	26.46
1x240	20086404	5DG4020	22.5	29.9	32.9	165	2830	3600	0.08	540	34.32
<b>(N)GRDGCGOEU-O screened power cables, single-core design</b>											
1x16C		5DG4211	5.7	10.1	12.1	61	320	240	1.21	99	2.29
1x25C		5DG4212	7.1	12.8	14.8	74	450	370	0.78	131	3.58
1x35C	20003445	5DG4213	8.3	13.7	15.7	79	540	520	0.55	162	5.01
1x50C	20003446	5DG4214	9.8	15.7	17.7	89	740	750	0.39	202	7.15
1x70C	20003447	5DG4215	11.6	18.7	20.7	104	1020	1050	0.27	250	10.01
1x95C	20003448	5DG4216	13.8	20.8	22.8	114	1260	1420	0.21	301	13.59
1x120C	20008791	5DG4217	14.9	22.8	24.8	124	1580	1800	0.16	352	17.16
1x150C		5DG4218	17.2	25.6	28.6	143	2000	2250	0.13	404	21.45
1x185C	20003449	5DG4219	18	27.7	30.7	154	2370	2770	0.11	461	26.46
1x240C		5DG4220	22.5	31.9	34.9	175	3130	3600	0.08	540	34.32
<b>(N)GRDGOEU-J multicore power cables</b>											
4x2,5	20025432	5DG4110	2	9.9	11.5	46	200	150	7.98	30	0.36
4x4	20003433	5DG4111	2.9	12.7	14.7	74	320	240	4.95	41	0.57
4x6	20003434	5DG4112	3.6	14.2	16.2	81	430	360	3.3	53	0.86
4x10	20003435	5DG4113	4.6	16.7	18.7	94	670	600	1.91	74	1.43
4x16	20003436	5DG4114	5.9	21.2	23.2	116	1020	960	1.21	99	2.29
4x25	20003437	5DG4115	7.2	26.5	29.5	148	1600	1500	0.78	131	3.58
3x35+3x16/3	20024514	5DG4116	8.1	26.4	29.4	147	1770	1570	0.55	162	5.01
3x50+3x25/3	20026619	5DG4117	10	31.5	34.5	173	2560	2250	0.39	202	7.15
3x70+3x35/3	20042007	5DG4119	11.9	37.6	40.6	203	3550	3150	0.27	250	10.01
5x6	20003438	5DG4122	3.6	15.8	17.8	89	530	450	3.3	53	0.86
5x10	20003439	5DG4123	4.6	19.7	21.7	109	850	750	1.91	74	1.43
5x16	20003440	5DG4124	5.9	23.4	25.4	127	1300	1200	1.21	99	2.29
<b>(N)GRDGCGOEU-J multicore power cables, overall screened</b>											
4x2,5C	20003450	5DG4240	1.9	11.2	13.2	66	310	150	7.98	30	0.36
4x4C	20003451	5DG4241	2.9	15.2	17.2	86	490	240	4.95	41	0.57
4x6C		5DG4242	3.6	17	19	95	650	360	3.3	53	0.86
4x10C	20003452	5DG4243	4.6	19.2	21.2	106	870	600	1.91	74	1.43
3x16+3x2,5C	20003453	5DG4254	5.9	20.3	22.3	112	1050	720	1.21	99	2.29
3x25+3x4C	20003454	5DG4255	7.2	25.7	28.7	144	1610	1120	0.78	131	3.58

Number of cores x cross section	Part number	MLFB Number	Conductor diameter max. mm	Outer diameter min. mm	Outer diameter max. mm	Bending radius free moving min. mm	Weight (ca.) kg/km	Permissible tensile force max. N	Conductor resistance at 20°C max. Ω/km	Current carrying capacity (1) A	Short Circuit Current (conductor) kA
3x35+3x6C	20003455	5DG4256	8.1	28.4	31.4	157	2140	1570	0.55	162	5.01
3x50+3x25/3	20003456	5DG4257	10	34.9	37.9	190	3080	2250	0.39	202	7.15
3x70+3x35/3	20003457	5DG4258	11.8	39.8	42.8	214	4090	3150	0.27	250	10.01
3x95+3x50/3	20099906	5DG4270	13.8	43.7	46.7	234	5080	4270	0.21	301	13.59
5x16C	20003459	5DG4264	5.9	25.7	28.7	144	1630	1200	1.21	99	2.29
(N)GRDGOEU-J control cables											
12x1,5	20154051	5DG4152	1.5	11.7	13.7	69	305	270	13.3	23	0.21
24x1,5	20003441	5DG4154	1.5	19.9	21.9	110	710	540	13.3	23	0.21
7x2,5		5DG4141	1.9	11.3	13.3	67	290	260	7.98	30	0.36
12x2,5	20003442	5DG4190	1.9	15.3	17.4	87	490	450	7.98	30	0.36
18x2,5	20003443	5DG4191	1.9	19.5	21.5	108	760	670	7.98	30	0.36
24x2,5	20003444	5DG4192	1.9	22.5	24.5	123	1020	900	7.98	30	0.36
(N)GRDGOEU-J overall screened control cables											
12x1,5C	20007106	5DG4252	1.5	14.6	16.6	83	490	180	7.98	23	0.36
5x2,5C	20007107	5DG4260	1.9	12.7	14.7	74	435	270	13.3	30	0.21
(N)GRDGOEU-O bus cables											
1x(2x0,5)C		5DG4***	0.9	8	10	40	135	10	39	10	0.07
(4x2x0,5)C	20007108	5DG4279	0.9	17.6	19.6	98	500	60	39	10	0.07
4x(2x0,5)C	20003460	5DG4280	0.9	19	21	105	590	60	39	10	0.07
6x(2x0,5)C	20003461	5DG4281	0.9	22.2	24.2	121	820	90	39	10	0.07
6x(2x1)C	20003458	5DG4259	1.3	26.3	29.3	147	1130	180	19.5	18	0.14
Fiber Optic											
6G62,5/125μ	20003462	5DG4290		12.6	14.6	73	250	500	n.a.	n.a.	n.a.
12G62,5/125μ	20003463	5DG4291		12.6	14.6	73	250	500	n.a.	n.a.	n.a.
6E9/125μ	20003464	5DG4292		12.6	14.6	73	250	500	n.a.	n.a.	n.a.
18G50/125μ	20003465	5DG4293		12.6	14.6	73	250	500	n.a.	n.a.	n.a.
12G50/125μ	20003466	5DG4294		12.6	14.6	73	250	500	n.a.	n.a.	n.a.
18G62,5/125μ	20024515	5DG4295		12.6	14.6	73	250	500	n.a.	n.a.	n.a.
6G50/125μ	20060691	5DG4296		12.6	14.6	73	250	500	n.a.	n.a.	n.a.

(1) Nominal current carrying capacity for rubber cables laid on a surface, at 30°C ambient temperature (see also VDE 0298-4, Table 15).



## FESTOONFLEX PUR-HF D12Y11Y

Low voltage round cable PUR sheathed for festoon application



### Application

For use as energy and control cable in festoon systems under severe conditions, incl. frequent bending. Also for drag lines, machine tools or materials handling systems.

In addition, suitable as drum reeling cable under moderate mechanical stress.

### Global data

Brand	FESTOONFLEX PUR-HF
Type designation	D12Y11Y-J/O

### Design features

Conductor	Plain copper, flexible class 5 acc. to DIN EN 60228 / DIN VDE 0295
Insulation	Halogen free compound, based on polyester
Core identification	Up to 5 cores: colored in accordance with DIN VDE 0293-308; From 6 cores: white with black numbers
Core arrangement	Cores twisted with short length of lay around central element
Outer sheath	Polyurethane, halogen free, flame retardant; Colour: black (opaque)
Marking	White imprint: FESTOONFLEX PUR-HF -J/-O (number of cores) x (cross-section) (year/week)

### Electrical parameters

Rated voltage	0.6/1 kV (600/1000V)
Max. permissible operating voltage AC	0.7/1.2 kV
Max. permissible operating voltage DC	0.9/1.8 kV
AC Test Voltage	4 kV (5 Min.)
Current Carrying Capacity description	Acc. to DIN VDE 0298-4

### Chemical parameters

Resistance to fire	Similar to IEC 60332-1
Water resistance	The cables are suitable for permanent use in water (no drinking water) up to 50 meter diving depth.

### Thermal parameters

Max. permissible temperature at conductor	90 °C
Max. short circuit temperature of the conductor	250 °C
Ambient temperature for fixed installation	min -50 °C ; max +80 °C
Ambient temperature in fully flexible operation	min -40 °C ; max +80 °C

### Mechanical parameters

Max. tensile load on the conductor	15 N/mm <sup>2</sup>
Torsional stress	± 25 °/m
Min. bending radius	6 x D (Proved by flexing tests acc. to HD 22.2 part 3.1)
Travel speed	- In festoon systems: up to 210 m/min; - For reeling operation: up to 60 m/min; - In chain systems: up to 210 m/min (note: trouble free operation is influenced by several factors, among all the chain length. For long chain system we recommend to operate at lower speed).

Number of cores x cross section	Part number	Conductor diameter max. mm	Outer diameter min. mm	Outer diameter max. mm	Bending radius free moving min. mm	Weight (ca.) kg/km	Permissible tensile force max. N	Conductor resistance at 20°C max. Ω/km	Current carrying capacity for install. free in air (2) A	Short Circuit Current (conductor) kA
D12Y11Y-O power cables, single core										
1x16	20165443	5	8.5	9.5	57	170	240	1.21	104	2.29
1x25	20156874	6.2	9.9	11.1	67	270	370	0.78	138	3.58
1x35	20154575	7.8	11.7	12.9	77	380	520	0.55	170	5.01
1x50	20154574	8.9	13.9	15.1	91	530	750	0.39	212	7.15
1x70	20154573	11.1	16.2	17.4	104	740	1050	0.27	263	10.01
1x95	20166593	12.6	17.9	19.1	115	940	1420	0.21	316	13.59
1x120	20156873	14.8	20.2	21.5	130	1200	1800	0.16	370	17.16
1x150		16	21.8	23.2	139	1490	2250	0.13	424	21.45
1x185		17.7	24.3	25.7	154	1830	2770	0.11	484	26.46
1x240		20.2	27.7	29.3	176	2300	3600	0.08	567	34.32
1x300		22.7	30	32	192	3200	4500	0.06	651	42.9
D12Y11Y-O power cables, three core										
3x1,5		1.5	6.5	7.5	45	115	60	13.3	24	0.21
3x2,5	20156877	2	8.5	9.5	57	130	110	7.98	32	0.36
D12Y11Y-J power cables, four core										
4x1,5		1.5	8.1	9.1	55	120	90	13.3	24	0.21
4x2,5	20156878	2	9.2	10.2	61	160	150	7.98	32	0.36
4x4	20160347	2.6	10.3	11.5	69	230	240	4.95	43	0.57
4x6		3.2	12.1	13.2	80	320	360	3.3	56	0.86
4x10	20154577	4	15	16.2	97	520	600	1.91	78	1.43
4x16	20156879	5	17.7	18.9	113	750	960	1.21	104	2.29
4x25	20160348	6.2	21.1	22.5	135	1160	1500	0.78	138	3.58
4x35		7.8	25.8	27.4	164	1650	2100	0.55	170	5.01
4x50		9.6	31	33	198	2410	3000	0.39	212	7.15
4x70		11.1	38.1	40.6	244	3070	4200	0.27	263	10.01
4x95		12.6	42.0	44.5	267	4150	5700	0.21	316	13.59
D12Y11Y-J power cables, five core										
5x1,5		1.5	8	9	54	150	110	13.3	24	0.21
5x2,5		2	9.8	11	66	180	180	7.98	32	0.36
5x4	20154579	2.6	11.6	12.7	77	290	300	4.95	43	0.57
5x6	20154578	3.2	14	15.2	91	420	450	3.3	56	0.86
5x10		4	16.2	17.5	105	630	750	1.91	78	1.43
5x16	20166492	5	19.4	20.6	124	920	1200	1.21	104	2.29
5x25		6.2	23.2	24.5	148	1380	1870	0.78	138	3.58
D12Y11Y-J Control cables										
7x1,5		1.5	9	10	60	220	150	13.3	24	0.21
12x1,5		1.5	14.3	15.5	93	320	270	13.3	24	0.21
18x1,5	20154580	1.5	14.5	15.7	94	380	400	13.3	24	0.21
24x1,5	20157942	1.5	16.5	17.8	107	500	540	13.3	24	0.21
30x1,5		1.5	19.6	21	126	680	670	13.3	24	0.21
36x1,5		1.5	21.1	22.5	135	770	810	13.3	24	0.21
7x2,5	20166594	2	11.5	12.7	76	250	260	7.98	32	0.36
12x2,5	20160349	2	16.5	17.7	106	460	450	7.98	32	0.36



Number of cores x cross section	Part number	Conductor diameter max. mm	Outer diameter min. mm	Outer diameter max. mm	Bending radius free moving min. mm	Weight (ca.) kg/km	Permissible tensile force max. N	Conductor resistance at 20°C max. Ω/km	Current carrying capacity for install. free in air (2) A	Short Circuit Current (conductor) kA
18x2,5	20149380	2	16.7	17.9	107	580	670	7.98	32	0.36
24x2,5	20149192	2	19.2	20.4	122	760	900	7.98	32	0.36
30x2,5		2	24.9	26.5	159	1080	1120	7.98	32	0.36
36x2,5		2	25.9	27.5	165	1300	1350	7.98	32	0.36

(2) Nominal current carrying capacity for rubber cables installed free in air, at 30°C ambient temperature (see also technical annexes). For articles without part number the values shown are approximate, and need to be confirmed in case of order.



## FESTOONFLEX C-PUR-HF D12YC11Y

Low voltage screened round cable PUR sheathed for festoon application



### Application

For use as energy and control cable in festoon systems under severe conditions, incl. frequent bending. Also for drag lines, machine tools or materials handling systems.

### Global data

Brand	FESTOONFLEX C PUR-HF
Type designation	D12YC11Y-J/O

### Design features

Conductor	Plain copper, flexible class 5 acc. to DIN EN 60228 / DIN VDE 0295
Insulation	Halogen free compound, based on polyester
Core identification	Up to 5 cores: colored in accordance with DIN VDE 0293-308 From 6 cores: natural color with black numbers
Core arrangement	Cores/Pairs twisted with short length of lay around central element
Inner sheath	Due to technical reasons some of the cross section are produced with an additional polyurethane inner sheath
Screen over inner sheath	Braid of tinned copper wires
Outer sheath	Polyurethane, halogen free, flame retardant; Colour: black (opaque).
Marking	White imprint: FESTOONFLEX C-PUR-HF -J/-O (number of cores) x (cross-section) (year/week)

### Electrical parameters

Rated voltage	0.6/1 kV (600/1000V)
Max. permissible operating voltage AC	0.7/1.2 kV
Max. permissible operating voltage DC	0.9/1.8 kV
AC Test Voltage	4 kV (5 Min.)
Current Carrying Capacity description	Acc. to DIN VDE 0298-4

### Chemical parameters

Resistance to fire	Similar to IEC 60332-1
Water resistance	The cables are suitable for permanent use in water (no drinking water) up to 50 meter diving depth.

### Thermal parameters

Max. permissible temperature at conductor	90 °C
Max. short circuit temperature of the conductor	250 °C
Ambient temperature for fixed installation	min -50 °C ; max +80 °C
Ambient temperature in fully flexible operation	min -40 °C ; max +80 °C

### Mechanical parameters

Max. tensile load on the conductor	15 N/mm <sup>2</sup>
Torsional stress	Not allowed
Min. bending radius	6 x D (Proved by flexing tests acc. to HD 22.2 part 3.1)
Travel speed	- In festoon systems: up to 210 m/min; - In chain systems: up to 210 m/min (note: trouble free operation is influenced by several factors, among all the chain length. For long chain system we recommend to operate at lower speed).

Number of cores x cross section	Part number	Conductor diameter max. mm	Outer diameter min. mm	Outer diameter max. mm	Bending radius free moving min. mm	Weight (ca.) kg/km	Permissible tensile force max. N	Conductor resistance at 20°C max. Ω/km	Current carrying capacity for install. free in air (2) A	Short Circuit Current (conductor) kA
D12YC11Y-O screened power cables, single core										
1x25		6.2	10.3	11.5	69	330	370	0.78	138	3.58
1x35	20161370	7.8	12.3	13.5	81	430	520	0.55	170	5.01
1x50		8.9	15.4	16.6	100	610	750	0.39	212	7.15
1x70	20157795	11.1	17.0	18.3	110	810	1050	0.27	263	10.01
1x95		12.6	18.9	20.1	121	1030	1420	0.21	316	13.59
1x120	20156875	14.8	21.4	22.8	137	1320	1800	0.16	370	17.16
1x150		16	23.1	24.5	147	1650	2250	0.13	424	21.45
1x185		17.7	25.5	27.2	163	2000	2770	0.11	484	26.46
1x240		20.2	28.5	30.1	181	2490	3600	0.08	567	34.32
D12YC11Y-J screened power cables, four core										
4x1,5		1.5	10.8	12	72	240	90	13.3	24	0.21
4x2,5	20166386	2	12.1	13.2	80	250	150	7.98	32	0.36
4x4		2.6	13.6	14.7	89	330	240	4.95	43	0.57
4x6	20161501	3.2	15.1	16.3	98	420	360	3.3	56	0.86
4x10		4	18.4	19.6	118	640	600	1.91	78	1.43
4x16	20166385	5	21.2	22.5	136	940	960	1.21	104	2.29
4x25		6.2	24.5	26.2	157	1360	1500	0.78	138	3.58
4x35	20168451	7.8	29.6	31.6	190	1870	2100	0.55	170	5.01
4x50		9.6	35.1	37.6	226	2560	3000	0.39	212	7.15
D12YC11Y-J screened power cables, five core										
5x1,5		1.5	10.9	12.1	73	250	110	13.3	24	0.21
5x2,5		2	12.8	14	84	280	180	7.98	32	0.36
5x4		2.6	13.8	15	90	345	300	4.95	43	0.57
D12YC11Y-J screened control cables										
7x1,5	20166387	1.5	10.9	12.1	73	220	150	13.3	24	0.21
12x1,5	20156247	1.5	15	16.2	97	360	270	13.3	24	0.21
18x1,5	20157796	1.5	15	16.2	97	420	400	13.3	24	0.21
12x2,5		2	17.4	18.6	112	530	450	7.98	32	0.36
18x2,5		2	17.5	18.8	113	650	670	7.98	32	0.36
D12YC11Y-O overall screened control pairs										
3x(2x1,5)		1.5	16.5	17.8	107	350	130	13.3	24	0.21
4x(2x1)		1.3	15.3	16.5	99	310	120	19.5	19	0.14
4x(2x1,5)		1.5	17.2	18.5	111	385	180	13.3	24	0.21
D12Y11Y-O individually screened control pairs										
4x(2x1)C	20161461	1.3	15.9	17.1	103	350	120	19.5	19	0.14
6x(2x1)C	20160120	1.3	19.0	20.3	122	480	180	19.5	19	0.14
9x(2x1)C		1.3	23.6	25	150	721	270	19.5	19	0.14
2x(2x1,5)C		1.5	15.2	16.4	98	280	90	13.3	24	0.21

Number of cores x cross section	Part number	Conductor diameter max. mm	Outer diameter min. mm	Outer diameter max. mm	Bending radius free moving min. mm	Weight (ca.) kg/km	Permissible tensile force max. N	Conductor resistance at 20°C max. Ω/km	Current carrying capacity for install. free in air (2) A	Short Circuit Current (conductor) kA
2x(2x2,5)C		2	17.2	18.5	111	340	150	7.98	32	0.36
3x(2x1,5)C	20156880	1.5	17.2	18.5	111	350	130	13.3	24	0.21
3x(2x2,5)C		2	17.5	18.8	113	390	220	7.98	32	0.36

(2) Nominal current carrying capacity for rubber cables installed free in air, at 30°C ambient temperature (see also technical annexes). For articles without part number the values shown are approximate, and need to be confirmed in case of order.



# Crane cables



# CABLES FOR DATA TRANSMISSION

	<b>OPTOFLEX</b>
Designation	
Dimension	Based on FDDI, ISO/IEC 9314T.3, DIN VDE 0888,
Cores	Fiber types: G62,5/125 $\mu$ , G50/125 $\mu$ , E9/125 $\mu$ 6, 12 , 18, 24 elements
Outer Sheath	Rubber
Approvals	
Tensile Load	500 N
Speed	Reeling: 120 m/min Festoon: 240 m/min
Temp. (moving)	-35°C/+80°C



## OPTOFLEX G62.5/125, G50/125, E9/125

### Rubber cable with fiber optic



#### Application

Flexible fibre optic cable for signal and data transmission on cranes and material handling equipment; suitable for cable handling systems, such as reels, festoon systems, cable tenders, etc. at high data rates, large bandwidth and absolute immunity to electromagnetic interference.

#### Global data

Brand	OPTOFLEX
Type designation	G62.5/125 $\mu$ , G50/125 $\mu$ , E9/125 $\mu$
Standard	Based on FDDI, ISO/IEC 9314 Part 3, DIN VDE 0888

#### Design features

Optical Fiber	Fibre core diameter: 62.5 $\mu$ m, 50 $\mu$ m or 9 $\mu$ m; Diameter across the cladding: 125 $\mu$ m; Diameter over the coating: 250 $\mu$ m;
Fiber coding	Specially developed colour code for identification of the individual fibres
Fiber covering	Hollow core with filling compound, Basic material: ETFE, Compound: 7YI 1, Natural color
Core arrangement	Six cores, especially laid-up in one layer around a GFK supporting element (GFK=glass-fibre reinforced plastic)
Inner sheath	Special compound
Reinforcement	Special braid made of polyester threads. Surface covered: approx. 80%
Outer sheath	Basic material PCP, rubber compound 5GM3 Colour black
Marking	(Year of manufacture) OPTOFLEX e.g. 6 G 62.5/125 Micron Germany

#### Chemical parameters

Resistance to oil	Acc. to DIN EN 60811-404 and DIN VDE 0473-811-404, paragraph 10
Weather resistance	Unrestricted use outdoors and indoors, resistant to ozone, UV and moisture

#### Thermal parameters

Ambient temperature for fixed installation	min -40 °C ; max +80 °C
Ambient temperature in fully flexible operation	min -35 °C ; max +80 °C

#### Mechanical parameters

Max. tensile load	500 N
Torsional stress	$\pm 50$ °/m
Min. bending radius	- fixed installation and on festoon system: 125 mm; - for reeling: 250mm;
Min. distance with S-type directional changes	20 x D (D=cable diameter)
Travel speed	- Gantry (reeling operation): up to 120 m/min (no random wound reel, cylindrical reel); - Trolley (festoon systems): up to 240 m/min (festoon, cable tender); - Hoist: no application;
Additional tests	Bending and reversed bending test

### Multimode fibers G62.5/125

Number of cores x cross section	Part number	MLFB Number	Outer diameter min. mm	Outer diameter max. mm	Net weight approx. kg/km	Max. attenuation at wavelength 850 nm dB/km	Max. attenuation at wavelength 1300 nm dB/km	Min. Bandwidth at 850 nm MHz	Min. Bandwidth at 1300 nm MHz	Numerical aperture ( $\pm 0.02$ )
6G62,5/125 $\mu$	20003597	5DG8002	14.9	17	280	3.3	0.9	400	600	0.275
12G62,5/125 $\mu$	20003608	5DG8035	14.9	17	280	3.3	0.9	400	600	0.275
18G62,5/125 $\mu$	20003599	5DG8012	14.9	17	280	3.3	0.9	400	600	0.275
24G62,5/125 $\mu$	20160114	5DG8...	14.9	17	280	3.3	0.9	400	600	0.275

A special design is also available, OPTOFLEX(M) with orange outer sheath (only for fixed installation, not suitable for reeling operation)

### Multimode fibers G50/125

Number of cores x cross section	Part number	MLFB Number	Outer diameter min. mm	Outer diameter max. mm	Net weight approx. kg/km	Max. attenuation at wavelength 850 nm dB/km	Max. attenuation at wavelength 1300 nm dB/km	Min. Bandwidth at 850 nm MHz	Min. Bandwidth at 1300 nm MHz	Numerical aperture ( $\pm 0.02$ )
6G50/125 $\mu$	20003598	5DG8004	14.9	17	280	2.8	0.8	400	1200	0.2
12G50/125 $\mu$	20113041	5DG8036	14.9	17	280	2.8	0.8	400	1200	0.2
18G50/125 $\mu$	20003600	5DG8014	14.9	17	280	2.8	0.8	400	1200	0.2
24G50/125 $\mu$	20160115	5DG8...	14.9	17	280	2.8	0.8	400	1200	0.2

A special design is also available, OPTOFLEX(M) with orange outer sheath (only for fixed installation, not suitable for reeling operation)

### Singlemode fibers E9/125

Number of cores x cross section	Part number	MLFB Number	Outer diameter min. mm	Outer diameter max. mm	Net weight approx. kg/km	Max. attenuation at wavelength 1300 nm dB/km	Max. attenuation at wavelength 1550 nm dB/km	Numerical aperture ( $\pm 0.02$ )	Chromatic dispersion at 1300 nm	Chromatic dispersion at 1550 nm
6E9/125 $\mu$	20003603	5DG8023	14.9	17	280	0.4	0.3	0.14	3.5	3.5
12E9/125 $\mu$	20039933	5DG8037	14.9	17	280	0.4	0.3	0.14	3.5	3.5
18E9/125 $\mu$	20026458	5DG8010	14.9	17	280	0.4	0.3	0.14	3.5	3.5
24E9/125 $\mu$	20160116	5DG8...	14.9	17	280	0.4	0.3	0.14	3.5	3.5

A special design is also available, OPTOFLEX(M) with orange outer sheath (only for fixed installation, not suitable for reeling operation)

# Crane cables



# ROUND MEDIUM VOLTAGE REELING CABLES

	PROTOLON (SMK)	PROTOLON (SMK) LWL	TENAX-TTS	TENAX-TTS LWL
Designation	(N)TSCGEW0EU	(N)TSKCGEW0EU	(N)TSCGEW0EU	(N)TSCGEW0EU
Dimension	Optimized based on DIN VDE 0250 part 813	Optimized based on DIN VDE 0250 part 813	Optimized based on DIN VDE 0250 part 813	Optimized based on DIN VDE 0250 part 813
Cores	3C+3G (also + control or BUS)	3C+2G+FO (also + control or BUS)	3C+3G	3C+2G+FO
Outer Sheath	Rubber RED	Rubber RED	Rubber RED or BLACK with yellow stripes	Rubber RED or BLACK with yellow stripes
Approvals	GOST-R	GOST-R		
Tensile Load	30 N/mm <sup>2</sup>	30 N/mm <sup>2</sup>	25 N/mm <sup>2</sup>	25 Nmm <sup>2</sup>
Speed	240 m/min	240 m/min	180m/min	180 m/min
Temp. (moving)	-35°C/+80°C (special to -45°C on request)	-35°C/+80°C (special to -45°C on request)	-25°C/+80°C	-25°C/+80°C

## PROTOLON(SMK) (N)TSCGEWOEU

### Medium voltage reeling cable



#### Application

Flexible medium voltage reeling cable for application under high to extreme mechanical stresses, e.g. high travel speeds, dynamic tensile loads, multiple changes of direction into different planes, churning on running over rollers and torsional stresses. Mainly for mobile equipment, e.g. fast-moving container cranes and large moving equipment.

#### Global data

Brand	PROTOLON(SMK)
Type designation	(N)TSCGEWOEU
Standard	Based on DIN VDE 0250-813
Certifications / Approvals	GOST-R

#### Design features

Conductor	Conductor and earth conductor made of electrolytic copper tinned, very finely stranded, class FS (refer also to DIN VDE 0295)
Insulation	PROTOLON HS High grade special compound based on high-quality EPR (at least 3GI3); improved mechanical and electrical characteristics (refer also to DIN VDE 0207, Part 20)
Electrical field control	Inner semiconductive layer of EPR, outer semiconductive layer of modified NBR, capable of being stripped when cold and thus extremely easy to prepare (Easy Strip design)
Core identification	Natural coloured insulation with black semiconductive layer
Core arrangement	Three-core design, with earth conductor split into 3 parts positioned in the interstices
Sheath system	- PROTOFIRM Sandwich - double layer inner sheath: Special compound based on EPR, quality at least 5GM3, also served as water barrier, color: red; - Anti-torsion braid: Reinforced braid made of polyester threads, in a vulcanized bond between the sheaths, resulting in high strength of the sheath system; - PROTOFIRM Sandwich - double layer outer sheath: A sheath system with a unique combination of flexibility and robustness has been achieved through the use of a new sandwich structure. Abrasion and tear-proof high grade rubber compounds based on PCP, quality at least 5GM5, colour: bright red/red.
Marking	PROTOLON (SMK) (N)TSCGEWOEU (number of cores)x(cross-section) (rated voltage) (year of manufacture) (serial number)

#### Electrical parameters

Rated voltage	1.8/3 kV	3.6/6 kV	6/10 kV	8.7/15 kV	12/20 kV
Max. permissible operating voltage AC	2.1/3.6 kV	4.2/7.2 kV	6.9/12 kV	10.4/18 kV	13.9/24 kV
Max. permissible operating voltage DC	2.7/5.4 kV	5.4/10.8 kV	9/18 kV	13.5/27 kV	18/36 kV
AC test voltage	6 kV	11 kV	17 kV	24 kV	29 kV
EMC	This design exhibits an extremely low interference level as a result of use of a symmetrical three-core design with very narrow manufacturing tolerances.				
Data transmission	Special designs with Twisted Shielded Pairs or Individually Screened control elements available on request. A special cable design with fibre optics can be found in the product range PROTOLON(SMK)-LWL.				
Current Carrying Capacity description	According to DIN VDE 0298, Part 4. Higher values are permissible in specific cases (please consult the manufacturer)				

#### Chemical parameters

Resistance to oil	Acc. to DIN EN 60811-404 and DIN VDE 0473-811-404, paragraph 10
Weather resistance	Unrestricted use outdoors and indoors, resistant to ozone, UV and moisture
Water resistance	According to HD 2216

#### Thermal parameters

Max. permissible temperature at conductor	90 °C
Max. short circuit temperature of the conductor	250 °C
Ambient temperature for fixed installation	min -50 °C ; max +80 °C
Ambient temperature in fully flexible operation	min -35 °C ; max +80 °C

### Mechanical parameters

Max. tensile load on the conductor	20 N/mm <sup>2</sup>
Max. tensile load on the conductor during acceleration	Up to 30 (acc. to DIN VDE 0298 part 3: 15 N/mm <sup>2</sup> ) N/mm <sup>2</sup>
Torsional stress	± 25 °/m
Min. bending radius	Acc. to DIN VDE 0298 part 3
Min. distance with S-type directional changes	20 x D (D = cable diameter)
Travel speed	- Gantry (reeling operation): no restriction. For speeds beyond 240 m/min it is recommended to consult the cable manufacturer.
Additional tests	Reversed bending test, torsional stress test

### Rated voltage 1.8/3 kV

Number of cores x cross section	Part number	MLFB Number	Conductor diameter max. mm	Earth conductor diameter max. mm	Outer diameter min. mm	Outer diameter max. mm	Bending radius free moving min. mm	Weight (ca.) kg/km	Permissible tensile force max. N	Dynamic tensile force max. N	Conductor resistance at 20°C max. Ω/km	Current carrying capacity (1) A	Short Circuit Current (conductor) kA
3x25+3x25/3	20004456	5DK2101	7.1	4.2	34.3	37.3	373	2110	1500	2250	0.8	131	3.58
3x35+3x25/3		5DK2102	8.3	4.2	43	46	460	3150	2100	3150	0.57	162	5.01
3x50+3x25/3	20143217	5DK2103	9.9	4.2	46.4	49.4	494	3840	3000	4500	0.39	202	7.15
3x70+3x35/3	20004457	5DK2104	11.8	5	45.9	48.9	489	4230	4200	6300	0.28	250	10.01
3x95+3x50/3	20004458	5DK2105	13.8	5.9	50.3	54.3	543	5440	5700	8550	0.21	301	13.59
3x120+3x70/3		5DK2106	15.4	7	63.8	67.8	678	8010	7200	10800	0.16	352	17.16
3x150+3x70/3		5DK2107	17.2	7	67.7	71.7	717	9240	9000	13500	0.13	404	21.45
3x185+3x95/3		5DK2108	19	8	71.6	75.6	756	10750	11100	16650	0.11	461	26.46
3x240+3x120/3		5DK2110	21.8	9	79.4	83.4	834	13640	14400	21600	0.08	540	34.32
3x300+3x150/3		5DK2111	24.4	10	84.7	89.7	897	16230	18000	27000	0.07	620	42.9

(1) Nominal current carrying capacity for rubber cables laid on a surface, at 30°C ambient temperature (see also VDE 0298-4, Table 15). Special designs upon request!

## Rated voltage 3.6/6 kV

Number of cores x cross section	Part number	MLFB Number	Conductor diameter max. mm	Earth conductor diameter max. mm	Outer diameter min. mm	Outer diameter max. mm	Bending radius free moving min. mm	Weight (ca.) kg/km	Permissible tensile force max. N	Dynamic tensile force max. N	Conductor resistance at 20°C max. Ω/km	Current carrying capacity (1) A	Short Circuit Current (conductor) kA
3x25+3x25/3	20004476	5DK3101	7.1	4.2	35.5	38.5	385	2210	1500	2250	0.8	131	3.58
3x35+3x25/3	20004477	5DK3102	8.3	4.2	39	42	420	2720	2100	3150	0.57	162	5.01
3x50+3x25/3	20004478	5DK3103	9.9	4.2	42.4	45.4	454	3380	3000	4500	0.39	202	7.15
3x70+3x35/3	20004479	5DK3104	11.8	5	46.4	49.4	494	4310	4200	6300	0.28	250	10.01
3x95+3x50/3	20004480	5DK3105	13.8	5.9	51.4	55.5	555	5570	5700	8550	0.21	301	13.59
3x120+3x70/3	20024335	5DK3106	15.4	7	55	59	590	6700	7200	10800	0.16	352	17.16
3x150+3x70/3	20004481	5DK3107	17.2	7	58.8	62.8	628	7820	9000	13500	0.13	404	21.45
3x185+3x95/3	20006940	5DK3108	19	8	64	68	680	9530	11100	16650	0.11	461	26.46
3x240+3x120/3		5DK3110	21.8	9	72.5	76.5	765	12120	14400	21600	0.08	540	34.32
3x300+3x150/3		5DK3111	24.4	10	78.2	82.2	822	14580	18000	27000	0.07	620	42.9

Special designs upon request!

(1) Nominal current carrying capacity for rubber cables laid on a surface, at 30°C ambient temperature (see also VDE 0298-4, Table 15).

## Rated voltage 6/10 kV

Number of cores x cross section	Part number	MLFB Number	Conductor diameter max. mm	Earth conductor diameter max. mm	Outer diameter min. mm	Outer diameter max. mm	Bending radius free moving min. mm	Weight (ca.) kg/km	Permissible tensile force max. N	Dynamic tensile force max. N	Conductor resistance at 20°C max. Ω/km	Current carrying capacity (1) A	Short Circuit Current (conductor) kA
3x25+3x25/3	20004539	5DK4061	7.1	4.2	37.8	40.8	408	2400	1500	2250	0.8	131	3.58
3x35+3x25/3	20001443	5DK4062	8.3	4.2	40.2	43.2	432	2830	2100	3150	0.57	162	5.01
3x35+3x35/3	20004545	5DK4072	8.3	5	40.2	43.2	432	2920	2100	3150	0.57	162	5.01
3x35+3x50/3	20008105	5DK4802	8.3	5.9	42.7	45.7	457	3280	2100	3150	0.57	162	5.01
3x50+3x25/3	20004540	5DK4063	9.9	4.2	43.7	46.7	467	3570	3000	4500	0.39	202	7.15
3x70+3x50/3	20004546	5DK4074	11.8	5.9	47.7	50.7	507	4570	4200	6300	0.28	250	10.01
3x95+3x50/3	20004541	5DK4065	13.8	5.9	52.8	56.8	568	5710	5700	8550	0.21	301	13.59
3x120+3x70/3	20004542	5DK4066	15.4	7	56.2	60.2	602	6840	7200	10800	0.16	352	17.16
3x150+3x70/3	20004543	5DK4067	17.2	7	61.5	65.5	655	8200	9000	13500	0.13	404	21.45
3x185+3x95/3	20004544	5DK4068	19	8	65.3	69.3	693	9690	11100	16650	0.11	461	26.46
3x240+3x120/3	20113369	5DK4070	21.8	9	73.8	77.8	778	12310	14400	21600	0.08	540	34.32
3x300+3x150/3	20154762	5DK4071	24.4	10	79.5	83.5	835	14780	18000	27000	0.07	620	42.9

(1) Nominal current carrying capacity for rubber cables laid on a surface, at 30°C ambient temperature (see also VDE 0298-4, Table 15).

Special designs upon request!

### Rated voltage 8.7/15 kV

Number of cores x cross section	Part number	MLFB Number	Conductor diameter max. mm	Earth conductor diameter max. mm	Outer diameter min. mm	Outer diameter max. mm	Bending radius free moving min. mm	Weight (ca.) kg/km	Permissible tensile force max. N	Dynamic tensile force max. N	Conductor resistance at 20°C max. Ω/km	Current carrying capacity (1) A	Short Circuit Current (conductor) kA
3x25+3x25/3	20004658	5DK5061	7.1	4.2	41.1	44.1	441	2680	1500	2250	0.8	139	3.58
3x35+3x25/3	20004659	5DK5062	8.3	4.2	43.7	46.7	467	3150	2100	3150	0.57	172	5.01
3x50+3x25/3	20004660	5DK5063	9.9	4.2	47.1	50.1	501	3840	3000	4500	0.39	215	7.15
3x70+3x35/3	20004661	5DK5064	11.8	5	52	56	560	5010	4200	6300	0.28	265	10.01
3x95+3x50/3	20148256	5DK5065	13.8	5.9	57.2	61.2	612	6070	5700	8550	0.21	319	13.59
3x120+3x70/3		5DK5066	15.4	7	62.1	66.1	661	7480	7200	10800	0.16	371	17.16
3x150+3x70/3		5DK5067	17.2	7	65.9	69.9	699	8630	9000	13500	0.13	428	21.45
3x185+3x95/3		5DK5068	19	8	69.8	73.8	738	10140	11100	16650	0.11	488	26.46
3x240+3x120/3		5DK5070	21.8	9	77.3	81.3	813	12860	14400	21600	0.08	574	34.32
3x300+3x150/3		5DK5071	24.4	10	84.2	89.2	892	15730	18000	27000	0.07	660	42.9

(1) Nominal current carrying capacity for rubber cables laid on a surface, at 30°C ambient temperature (see also VDE 0298-4, Table 15).  
Special designs upon request!

### Rated voltage 12/20 kV

Number of cores x cross section	Part number	MLFB Number	Conductor diameter max. mm	Earth conductor diameter max. mm	Outer diameter min. mm	Outer diameter max. mm	Bending radius free moving min. mm	Weight (ca.) kg/km	Permissible tensile force max. N	Dynamic tensile force max. N	Conductor resistance at 20°C max. Ω/km	Current carrying capacity (1) A	Short Circuit Current (conductor) kA
3x25+3x25/3	20004698	5DK5521	7.1	4.2	44.1	47.1	471	2950	1500	2250	0.8	139	3.58
3x35+3x25/3	20004699	5DK5522	8.3	4.2	46.6	49.6	496	3440	2100	3150	0.57	172	5.01
3x50+3x25/3	20119477	5DK5523	9.9	4.2	51.8	55.8	558	4300	3000	4500	0.39	215	7.15
3x70+3x35/3	20025103	5DK5524	11.8	5	55	59	590	5350	4200	6300	0.28	265	10.01
3x95+3x50/3	20004700	5DK5525	13.8	5.9	61.6	65.6	656	6660	5700	8550	0.21	319	13.59
3x120+3x70/3	20168895	5DK5526	15.4	7	65.1	69.1	691	7870	7200	10800	0.16	371	17.16
3x150+3x70/3		5DK5527	17.2	7	69	73	730	9060	9000	13500	0.13	428	21.45
3x185+3x95/3		5DK5528	19	8	74.3	78.3	783	10850	11100	16650	0.11	488	26.46
3x240+3x120/3		5DK5530	21.8	9	80.3	84.3	843	13340	14400	21600	0.08	574	34.32
3x300+3x150/3		5DK5532	24.4	10	87.2	92.2	922	16250	18000	27000	0.07	660	42.9

Special designs upon request!

(1) Nominal current carrying capacity for rubber cables laid on a surface, at 30°C ambient temperature (see also VDE 0298-4, Table 15).



## PROTOLON(SMK)-LWL (N)TSKCGEWOEU

### Medium voltage reeling cable with fiber optics



#### Application

Flexible medium voltage reeling cable with integrated fibre-optics for the combined transmission of energy and data, for application under high or extreme mechanical stresses, e.g. high travel speeds, dynamic tensile loads, multiple changes of direction into different planes, churning on running over rollers and torsional stresses.

Mainly for mobile equipment, e.g. fast-moving container cranes and large moving equipment.

#### Global data

Brand	PROTOLON(SMK)-LWL
Type designation	(N)TSKCGEWOEU
Standard	Based on DIN VDE 0250-813
Certifications / Approvals	GOST-R

#### Notes on installation

Notes on installation	Preparation of fibre-optics requires special skills and use of elaborate tools. It is therefore recommended that performance of this work is entrusted to our customer service (Factory assembly). Please provide the connection dimensions.
-----------------------	--

#### Design features

Conductor	Conductor and earth conductor made of electrolytic copper tinned, very finely stranded, class FS (refer also to DIN VDE 0295)			
Insulation	PROTOLON HS High grade special compound based on high-quality EPR (at least 3GI3); improved mechanical and electrical characteristics (refer also to DIN VDE 0207, Part 20).			
Electrical field control	Inner semiconductive layer of EPR, outer semiconductive layer of modified NBR, capable of being stripped when cold and thus extremely easy to prepare (Easy Strip design)			
Core identification	Natural coloured insulation with black semiconductive layer			
Optical Fiber	Fibre core diameter: 62.5, 50 or 9µm; diameter across the cladding: 125µm; diameter over the coating: 250µm. Design available with 6,12, 18 or 24 fibres.			
	Fibre class:	G50/125µm	G62,5/125µm	E9/125µm
	Type:	Graded-index fibre	Graded-index fibre	Monomode fibre
	- Attenuation at 850 nm:	<2,8 dB/km	<3,3 dB/km	-
	- Attenuation at 1310 nm:	<0,8 dB/km	<0,9 dB/km	<0,4 dB/km
	- Attenuation at 1550 nm:	-	-	<0,3 dB/km
	- Bandwidth at 850 nm:	>400 MHz	>400 MHz	-
	- Bandwidth at 1300 nm:	>1200 MHz	>600 MHz	-
	- Numerical aperture:	0,2 ± 0,02	0,275 ± 0,02	0,14 ± 0,02
	- Chromatic dispersion at 1300 nm:	-	-	<3,5 ps/nm km
	- Chromatic dispersion at 1550 nm:	-	-	<3,5 ps/nm km
Fiber coding	Specially developed color code for identification of the individual fibres			
Fiber covering	Hollow core with filling compound, Basic material: ETFE, Compound: 7YI 1, Natural color			
Core arrangement	Three core design with cradle separator in the centre, earth conductor splitted into 2 parts positioned in two interstices. Optical element: six tubes, laid up around a central support element, with one, two or three optical fibers in each, positioned in the third interstice.			
Sheath system	- PROTOFIRM Sandwich - double layer inner sheath: Special compound based on EPR, quality at least 5GM3, also served as water barrier, color: red; - Anti-torsion braid: Reinforced braid made of polyester threads, in a vulcanized bond between the sheaths, resulting in high strength of the sheath system; - PROTOFIRM Sandwich - double layer outer sheath: A sheath system with a unique combination of flexibility and robustness has been achieved through the use of a new sandwich structure. Abrasion and tear-proof high grade rubber compounds based on PCP, quality at least 5GM5, colour: bright red/red.			
Marking	PROTOLON (SMK) LWL (N)TSKCGEWOEU (number of cores)x(cross-section) (rated voltage) (year of manufacture) (serial number)			

### Electrical parameters

Rated voltage	3.6/6 kV	6/10 kV	8.7/15 kV	12/20 kV
Max. permissible operating voltage AC	4.2/7.2 kV	6.9/12 kV	10.4/18 kV	13.9/24 kV
Max. permissible operating voltage DC	5.4/10.8 kV	9/18 kV	13.5/27 kV	18/36 kV
AC test voltage	11 kV	17 kV	24 kV	29 kV
EMC	This design exhibits an extremely low interference level as a result of use a symmetrical three-core design with very narrow manufacturing rates.			
Data transmission	Special design with fibre-optics for trouble free data transmission at high data rates.			
Current Carrying Capacity description	According to DIN VDE 0298, Part 4. Higher values are permissible in specific cases (please consult the manufacturer).			

### Chemical parameters

Resistance to oil	Acc. to DIN EN 60811-404 and DIN VDE 0473-811-404, paragraph 10
Weather resistance	Unrestricted use outdoors and indoors, resistant to ozone, UV and moisture.
Water resistance	According to HD 2216

### Thermal parameters

Max. permissible temperature at conductor	90 °C
Max. short circuit temperature of the conductor	250 °C
Ambient temperature for fixed installation	min -50 °C ; max +80 °C
Ambient temperature in fully flexible operation	min -35 °C ; max +80 °C

### Mechanical parameters

Max. tensile load on the conductor	20 N/mm <sup>2</sup>
Max. tensile load on the conductor during acceleration	Up to 30 (acc. to DIN VDE 0298 part 3: 15 N/mm <sup>2</sup> ) N/mm <sup>2</sup>
Torsional stress	± 25 °/m
Min. bending radius	Acc. to DIN VDE 0298 part 3
Min. distance with S-type directional changes	20 x D (cable diameter)
Travel speed	- Gantry (reeling operation): no restriction. For speeds beyond 240 m/min it is recommended to consult the cable manufacturer
Additional tests	Reversed bending test, torsional stress test

## Rated voltage 3.6/6 kV

Number of cores x cross section	Part number	MLFB Number	Conductor diameter max. mm	Earth conductor diameter max. mm	Outer diameter min. mm	Outer diameter max. mm	Bending radius free moving min. mm	Weight (ca.) kg/km	Permissible tensile force max. N	Dynamic tensile force max. N	Conductor resistance at 20°C max. Ω/km	Current carrying capacity (1) A	Short Circuit Current (conductor) kA
3x25 + 2x25/2 + 1x(6G62,5)		5DK3081	7.1	5	39.9	42.9	429	2570	1500	2250	0.8	131	3.58
3x35 + 2x25/2 + 1x(6G62,5)	20004468	5DK3082	8.3	5	42	45	450	2990	2100	3150	0.57	162	5.01
3x50 + 2x25/2 + 1x(6G62,5)	20004469	5DK3083	9.9	5	44.8	47.8	478	3660	3000	4500	0.39	202	7.15
3x70 + 2x35/2 + 1x(6G62,5)	20004470	5DK3084	11.8	5.9	49.9	53.9	539	4740	4200	6300	0.28	250	10.01
3x95 + 2x50/2 + 1x(6G62,5)	20004471	5DK3085	13.8	7.2	54.8	58.8	588	5920	5700	8550	0.21	301	13.59
3x120 + 2x70/2 + 1x(6G62,5)	20008293	5DK3086	15.4	8.3	58.2	62.2	622	7130	7200	10800	0.16	352	17.16
3x150 + 2x70/2 + 1x(6G62,5)	20007743	5DK3100	17.2	8.3	63.5	67.5	675	8500	9000	13500	0.13	404	21.45

Design with 12,18 or 24 fibers and/or G50 or E9 types available upon request.

(1) Nominal current carrying capacity for rubber cables laid on a surface, at 30°C ambient temperature (see also VDE 0298-4, Table 15).

## Rated voltage 6/10 kV

Number of cores x cross section	Part number	MLFB Number	Conductor diameter max. mm	Earth conductor diameter max. mm	Outer diameter min. mm	Outer diameter max. mm	Bending radius free moving min. mm	Weight (ca.) kg/km	Permissible tensile force max. N	Dynamic tensile force max. N	Conductor resistance at 20°C max. Ω/km	Current carrying capacity (1) A	Short Circuit Current (conductor) kA
3x25 + 2x25/2 + 1x(6G62,5)	20004548	5DK4081	7.1	5	40.7	43.7	437	2640	1500	2250	0.8	131	3.58
3x35 + 2x25/2 + 1x(6G62,5)	20004549	5DK4082	8.3	5	42.7	45.7	457	3060	2100	3150	0.57	162	5.01
3x50 + 2x25/2 + 1x(6G62,5)	20004550	5DK4083	9.9	5	46.1	49.1	491	3730	3000	4500	0.39	202	7.15
3x70 + 2x35/2 + 1x(6G62,5)	20004551	5DK4084	11.8	5.9	51.1	55.1	551	4870	4200	6300	0.28	250	10.01
3x95 + 2x50/2 + 1x(6G62,5)	20004552	5DK4085	13.8	7.2	56.1	60.1	601	6070	5700	8550	0.21	301	13.59
3x120 + 2x70/2 + 1x(6G62,5)	20006945	5DK4086	15.4	8.3	60.9	64.9	649	7500	7200	10800	0.16	352	17.16
3x150 + 2x70/2 + 1x(6G62,5)	20004553	5DK4087	17.2	8.3	64.8	68.8	688	8670	9000	13500	0.13	404	21.45
3x185 + 2x95/2 + 1x(6G62,5)	20007673	5DK4088	19	9.8	69.3	73.3	733	10290	11100	16650	0.11	461	26.46
3x240 + 2x120/2 + 1x(6G62,5)	20035801	5DK4090	21.8	11	76.7	80.7	807	12960	14400	21600	0.08	540	34.32
3x300 + 2x150/2 + 1x(6G62,5)		5DK4091	24.4	12	84.2	89.2	892	15880	18000	27000	0.07	620	42.9

Design with 12,18 or 24 fibers and/or G50 or E9 types available upon request.

(1) Nominal current carrying capacity for rubber cables laid on a surface, at 30°C ambient temperature (see also VDE 0298-4, Table 15).

### Rated voltage 8.7/15 kV

Number of cores x cross section	Part number	MLFB Number	Conductor diameter max. mm	Earth conductor diameter max. mm	Outer diameter min. mm	Outer diameter max. mm	Bending radius free moving min. mm	Weight (ca.) kg/km	Permissible tensile force max. N	Dynamic tensile force max. N	Conductor resistance at 20°C max. Ω/km	Current carrying capacity (1) A	Short Circuit Current (conductor) kA
3x25 + 2x25/2 + 1x(6G62,5)	20004664	5DK5078	7.1	5	43.5	46.5	465	2890	1500	2250	0.8	139	3.58
3x35 + 2x25/2 + 1x(6G62,5)	20004667	5DK5082	8.3	5	46.1	49.1	491	3380	2100	3150	0.57	172	5.01
3x50 + 2x25/2 + 1x(6G62,5)	20004668	5DK5083	9.9	5	50.5	54.5	545	4260	3000	4500	0.39	215	7.15
3x70 + 2x35/2 + 1x(6G62,5)	20004669	5DK5084	11.8	5.9	55.2	59.2	592	5350	4200	6300	0.28	265	10.01
3x95 + 2x50/2 + 1x(6G62,5)		5DK5***	13.8	7.2	60.9	64.9	649	6700	5700	8550	0.21	319	13.59
3x120 + 2x70/2 + 1x(6G62,5)		5DK5***	15.4	8.3	64.4	68.4	684	7870	7200	10800	0.16	371	17.16
3x150 + 2x70/2 + 1x(6G62,5)		5DK5***	17.2	8.3	68.8	72.8	728	9130	9000	13500	0.13	428	21.45
3x185 + 2x95/2 + 1x(6G62,5)		5DK5***	19	9.8	74.1	78.1	781	10920	11100	16650	0.11	488	26.46
3x240 + 2x120/2 + 1x(6G62,5)		5DK5***	21.8	11	80.8	84.8	848	13560	14400	21600	0.08	574	34.32
3x300 + 2x150/2 + 1x(6G62,5)		5DK5***	24.4	12	87.7	92.7	927	16510	18000	27000	0.07	660	42.9

(1) Nominal current carrying capacity for rubber cables laid on a surface, at 30°C ambient temperature (see also VDE 0298-4, Table 15). Design with 12,18 or 24 fibers and/or G50 or E9 types available upon request.

### Rated voltage 12/20 kV

Number of cores x cross section	Part number	MLFB Number	Conductor diameter max. mm	Earth conductor diameter max. mm	Outer diameter min. mm	Outer diameter max. mm	Bending radius free moving min. mm	Weight (ca.) kg/km	Permissible tensile force max. N	Dynamic tensile force max. N	Conductor resistance at 20°C max. Ω/km	Current carrying capacity (1) A	Short Circuit Current (conductor) kA
3x25 + 2x25/2 + 1x(6G62,5)	20004701	5DK5531	7.1	5	46.6	49.6	496	3200	1500	2250	0.8	139	3.58
3x35 + 2x25/2 + 1x(6G62,5)	20004702	5DK5533	8.3	5	50.1	54.1	541	3880	2100	3150	0.57	172	5.01
3x50 + 2x25/2 + 1x(6G62,5)		5DK5***	9.9	5	54.1	58.1	581	4670	3000	4500	0.39	215	7.15
3x70 + 2x35/2 + 1x(6G62,5)	20168072	5DK5***	11.8	5.9	58.2	62.2	622	5640	4200	6300	0.28	265	10.01
3x95 + 2x50/2 + 1x(6G62,5)		5DK5***	13.8	7.2	64	68	680	7050	5700	8550	0.21	319	13.59
3x120 + 2x70/2 + 1x(6G62,5)		5DK5***	15.4	8.3	68	72	720	8360	7200	10800	0.16	371	17.16
3x150 + 2x70/2 + 1x(6G62,5)	20161633	5DK5***	17.2	8.3	73.3	77.3	773	9840	9000	13500	0.13	428	21.45
3x185 + 2x95/2 + 1x(6G62,5)		5DK5***	19	9.8	77.2	81.2	812	11410	11100	16650	0.11	488	26.46
3x240 + 2x120/2 + 1x(6G62,5)		5DK5***	21.8	11	85.1	90.1	901	14440	14400	21600	0.08	574	34.32
3x300 + 2x150/2 + 1x(6G62,5)		5DK5***	24.4	12	91.3	96.3	963	17810	18000	27000	0.07	660	42.9

Design with 12,18 or 24 fibers and/or G50 or E9 types available upon request.

(1) Nominal current carrying capacity for rubber cables laid on a surface, at 30°C ambient temperature (see also VDE 0298-4, Table 15).

## (N)TSCGEWOEU TENAX TTS

### Medium voltage reeling cable



#### Application

Flexible medium voltage reeling cable for application under high mechanical stresses, e.g. high travel speeds, dynamic tensile loads, multiple changes of direction into different planes, churning on running over rollers and torsional stresses. Mainly for mobile equipment, e.g. fast-moving container cranes and large moving equipment.

#### Global data

Brand	TENAX-TTS
Type designation	(N)TSCGEWOEU
Standard	Based on DIN VDE 0250-813

#### Design features

Conductor	Plain copper, fine stranded class 5 according to DIN EN 60228 / VDE 0295
Insulation	Rubber, compound type EPR-SHS EI6, super-clean
Electrical field control	Inner and outer layer of semiconductive rubber compound
Core arrangement	Cores layed up around conductive filler with aramid rope in the center, earth conductor split into the interstices.
Inner sheath	Rubber, special compound, mechanical properties acc. to 5GM3
Reinforcement	Polyester anti-torsion braid
Outer sheath	Abrasion and tear proof special rubber compound, quality at least 5GM5 acc. to DIN VDE 0207 part 21, resistance to ozone, UV and oil. Sheath colour: red or black with yellow stripe
Marking	Embossed: (N)TSCGEWOEU (number of cores) x (cross-section) (rated voltage) DRAKA DE VDE (Year of manufacture) TENAX TTS

#### Electrical parameters

Rated voltage	3.6/6 kV	6/10 kV	8.7/15 kV	12/20 kV
Max. permissible operating voltage AC	4.2/7.2 kV	6.9/12 kV	10.4/18 kV	13.9/24 kV
Max. permissible operating voltage DC	5.4/10.8 kV	9/18 kV	13.5/27 kV	18/36 kV
AC test voltage	11 kV	17 kV	24 kV	29 kV
Current Carrying Capacity description	According to DIN VDE 0298 Part 4			

#### Thermal parameters

Max. permissible temperature at conductor	90 °C
Max. short circuit temperature of the conductor	250 °C
Ambient temperature for fixed installation	min -40 °C ; max +80 °C
Ambient temperature in fully flexible operation	min -25 °C ; max +80 °C

#### Mechanical parameters

Max. tensile load on the conductor	20 N/mm <sup>2</sup>
Max. tensile load on the conductor during acceleration	25 N/mm <sup>2</sup>
Torsional stress	± 50 °/m
Min. bending radius	Acc. to DIN VDE 0298 part 3
Min. distance with S-type directional changes	20 X D
Travel speed	- Reeling operation: up to 180 m/min

### Rated voltage 3.6/6 kV

Number of cores x cross section	Part number	Conductor diameter max. mm	Outer diameter min. mm	Outer diameter max. mm	Bending radius free moving min. mm	Weight (ca.) kg/km	Permissible tensile force max. N	Dynamic tensile force max. N	Conductor resistance at 20°C max. Ω/km	Nom. operating capacitance μF/km	Inductive Reactance (at 50Hz) Ω/km	Current carrying capacity (1) A	Short Circuit Current (conductor) kA
3x16+3x16/3		5	36	39	390	1970	960	1200	1.21	0.3	0.121	99	2.29
3x25+3x25/3		6.2	38.5	41.5	415	2380	1500	1875	0.78	0.38	0.102	131	3.58
3x35+3x25/3	20074704	7.7	41.5	44.5	445	2830	2100	2625	0.55	0.43	0.097	162	5.01
3x50+3x25/3	20074720	9.3	44.5	47.5	475	3390	3000	3750	0.39	0.49	0.092	202	7.15
3x70+3x35/3		11.5	50	54	540	4400	4200	5250	0.27	0.55	0.088	250	10.01
3x95+3x50/3		12.8	54	58	580	5300	5700	7125	0.21	0.62	0.084	301	13.59
3x120+3x70/3		14.9	58	62	620	6400	7200	9000	0.16	0.67	0.082	352	17.16
3x150+3x70/3		16.5	63	67	670	7600	9000	11250	0.13	0.73	0.08	404	21.45
3x185+3x95/3		18.5	67	72	720	9200	11100	13875	0.11	0.79	0.078	461	26.46

(1) Nominal current carrying capacity for rubber cables laid on a surface, at 30°C ambient temperature (see also VDE 0298-4, Table 15).

### Rated voltage 6/10 kV

Number of cores x cross section	Part number	Conductor diameter max. mm	Outer diameter min. mm	Outer diameter max. mm	Bending radius free moving min. mm	Weight (ca.) kg/km	Permissible tensile force max. N	Dynamic tensile force max. N	Conductor resistance at 20°C max. Ω/km	Nom. operating capacitance μF/km	Inductive Reactance (at 50Hz) Ω/km	Current carrying capacity (1) A	Short Circuit Current (conductor) kA
3x16/16		5	37	41	410	2055	960	1200	1.21	0.26	0.118	99	2.29
3x16+3x16/3	20074723	5	36	39	390	1910	960	1200	1.21	0.26	0.118	99	2.29
3x25+3x25/3	20074717	6.2	40	43	430	2340	1500	1875	0.78	0.35	0.104	131	3.58
3x35+3x25/3	20119291	7.7	43	46	460	2890	2100	2625	0.55	0.39	0.099	162	5.01
3x50+3x25/3	20074713	9.3	45	48	480	3390	3000	3750	0.39	0.45	0.094	202	7.15
3x70+3x35/3	20126712	11.5	50.5	54.5	545	4480	4200	5250	0.27	0.51	0.09	250	10.01
3x95+3x50/3		12.8	54.5	58.5	585	5400	5700	7125	0.21	0.58	0.086	301	13.59
3x120+3x70/3		14.9	58.5	62.5	625	6700	7200	9000	0.16	0.63	0.084	352	17.16
3x150+3x70/3		16.5	63	67	670	7600	9000	11250	0.13	0.69	0.082	404	21.45
3x185+3x95/3		18.5	68	73	730	9350	11100	13875	0.11	0.75	0.08	461	26.46
3x240+3x120/3		21	73	78	780	11850	14400	18000	0.08	0.83	0.078	540	34.32

(1) Nominal current carrying capacity for rubber cables laid on a surface, at 30°C ambient temperature (see also VDE 0298-4, Table 15).

## Rated voltage 8.7/15 kV

Number of cores x cross section	Part number	Conductor diameter max. mm	Outer diameter min. mm	Outer diameter max. mm	Bending radius free moving min. mm	Weight (ca.) kg/km	Permissible tensile force max. N	Dynamic tensile force max. N	Conductor resistance at 20°C max. Ω/km	Nom. operating capacitance μF/km	Inductive Reactance (at 50Hz) Ω/km	Current carrying capacity (1) A	Short Circuit Current (conductor) kA
3x16+3x16/3		5	39	42	420	2210	960	1200	1.21	0.22	0.121	105	2.29
3x25+3x25/3	20121561	6.2	42	45	450	2550	1500	1875	0.78	0.3	0.11	139	3.58
3x35+3x25/3		7.7	45	49	490	3100	2100	2625	0.55	0.33	0.105	172	5.01
3x50+3x25/3	20100279	9.3	49	53	530	3720	3000	3750	0.39	0.37	0.099	215	7.15
3x70+3x35/3		11.5	53	57	570	5050	4200	5250	0.27	0.42	0.094	265	10.01
3x95+3x50/3	20101412	12.8	58	62	620	5900	5700	7125	0.21	0.48	0.089	319	13.59
3x120+3x70/3		14.9	63	67	670	7265	7200	9000	0.16	0.52	0.087	371	17.16
3x150+3x70/3		16.5	66	70	700	8500	9000	11250	0.13	0.57	0.085	428	21.45
3x185+3x95/3		18.5	70	74	740	9900	11100	13875	0.11	0.61	0.083	488	26.46

(1) Nominal current carrying capacity for rubber cables laid on a surface, at 30°C ambient temperature (see also VDE 0298-4, Table 15).

## Rated voltage 12/20 kV

Number of cores x cross section	Part number	Conductor diameter max. mm	Outer diameter min. mm	Outer diameter max. mm	Bending radius free moving min. mm	Weight (ca.) kg/km	Permissible tensile force max. N	Dynamic tensile force max. N	Conductor resistance at 20°C max. Ω/km	Nom. operating capacitance μF/km	Inductive Reactance (at 50Hz) Ω/km	Current carrying capacity (1) A	Short Circuit Current (conductor) kA
3x25+3x25/3	20074721	6.2	45	48	480	2860	1500	1875	0.78	0.24	0.115	139	3.58
3x35+3x25/3		7.7	48	51	510	3250	2100	2625	0.55	0.27	0.109	172	5.01
3x50+3x25/3		9.3	51	55	550	4050	3000	3750	0.39	0.3	0.103	215	7.15
3x70+3x35/3	20074735	11.5	56	60	600	4800	4200	5250	0.27	0.34	0.098	265	10.01
3x95+3x50/3		12.8	60	64	640	6450	5700	7125	0.21	0.38	0.094	319	13.59
3x120+3x70/3		14.9	66	70	700	7700	7200	9000	0.16	0.41	0.091	371	17.16
3x150+3x70/3		16.5	69	73	730	8550	9000	11250	0.13	0.45	0.089	428	21.45
3x185+3x95/3		18.5	75	79	790	10600	11100	13875	0.11	0.49	0.086	488	26.46

(1) Nominal current carrying capacity for rubber cables laid on a surface, at 30°C ambient temperature (see also VDE 0298-4, Table 15).





## (N)TSCGEW0EU TENAX TTS-LWL

### Medium voltage reeling cable with fibre-optics



#### Application

Flexible medium voltage reeling cable with integrated fibre-optics for the combined transmission of energy and data, for application under high mechanical stresses, e.g. high travel speeds, dynamic tensile loads, multiple changes of direction into different planes, churning on running over rollers and torsional stresses.

Mainly for mobile equipment, e.g. fast-moving container cranes and large moving equipment.

#### Global data

Brand	TENAX-TTS
Type designation	(N)TSCGEW0EU
Standard	Based on DIN VDE 0250-813

#### Design features

Conductor	Plain copper, fine stranded class 5 according to DIN EN 60228 / VDE 0295
Insulation	Rubber, compound type EPR-SHS EI6, super-clean
Electrical field control	Inner and outer layer of semiconductive rubber compound
Optical Fiber	12 fibers, 50/125µ or 62.5/125µ or E9/125µ, within protection jacket.

Fibre class:	G50/125µm	G62,5/125µm	E9/125µm
Type:	Graded-index fibre	Graded-index fibre	Monomode fibre
- Attenuation at 850 nm:	<2,8 dB/km	<3,3 dB/km	-
- Attenuation at 1300 nm:	<0,8 dB/km	<0,9 dB/km	<0,4 dB/km
- Attenuation at 1550 nm:	-	-	<0,3 dB/km
- Bandwidth at 850 nm:	>400 MHz	>200 MHz	-
- Bandwidth at 1300 nm:	>1200 MHz	>500 MHz	-
- Numerical aperture:	0,2 ± 0,02	0,27 ± 0,02	-
- Chromatic dispersion at 1300 nm:	-	-	<3,5 ps/nm km
- Chromatic dispersion at 1550 nm:	-	-	<18 ps/nm km

Core arrangement	Cores layed up around conductive filler with aramid rope in the center
Inner sheath	Rubber, special compound, mechanical properties acc. to 5GM3
Reinforcement	Polyester anti-torsion braid
Outer sheath	Abrasion and tear proof special rubber compound, quality at least 5GM5 acc. to DIN VDE 0207 part 21, resistance to ozone, UV and oil. Sheath colour: red or black with yellow stripe
Marking	Embossed: (N)TSCGEW0EU (number of cores) x (cross-section) (rated voltage) DRAKA DE VDE (Year of manufacture) TENAX TTS

#### Electrical parameters

Rated voltage	3.6/6 kV	6/10 kV	8.7/15 kV	12/20 kV
Max. permissible operating voltage AC	4.2/7.2 kV	6.9/12 kV	10.4/18 kV	13.9/24 kV
Max. permissible operating voltage DC	5.4/10.8 kV	9/18 kV	13.5/27 kV	18/36 kV
AC test voltage	11 kV	17 kV	24 kV	29 kV
Current Carrying Capacity description	According to DIN VDE 0298 Part 4			

#### Thermal parameters

Max. permissible temperature at conductor	90 °C
Max. short circuit temperature of the conductor	250 °C
Ambient temperature for fixed installation	min -40 °C ; max +80 °C
Ambient temperature in fully flexible operation	min -25 °C ; max +80 °C

### Mechanical parameters

Max. tensile load on the conductor	20 N/mm <sup>2</sup>
Max. tensile load on the conductor during acceleration	25 N/mm <sup>2</sup>
Torsional stress	± 50 °/m
Min. bending radius	Acc. to DIN VDE 0298 part 3
Min. distance with S-type directional changes	20 X D
Travel speed	- Reeling operation: up to 180 m/min

### Rated voltage 3.6/6 kV

Number of cores x cross section	Conductor diameter max. mm	Outer diameter min. mm	Outer diameter max. mm	Bending radius free moving min. mm	Weight (ca.) kg/km	Permissible tensile force max. N	Dynamic tensile force max. N	Conductor resistance at 20°C max. Ω/km	Nom. operating capacitance μF/km	Inductive Reactance (at 50Hz) Ω/km	Current carrying capacity (1) A	Short Circuit Current (conductor) kA
3x25 + 2x25/2 + 1x(12G62,5)	6.2	38.5	41.5	415	2380	1500	1875	0.78	0.38	0.102	131	3.58
3x35 + 2x25/2 + 1x(12G62,5)	7.7	41.5	44.5	445	2750	2100	2625	0.55	0.49	0.092	202	5.01
3x50 + 2x25/2 + 1x(12G62,5)	9.3	44.5	47.5	475	3100	3000	3750	0.39	0.49	0.092	202	7.15
3x70 + 2x35/2 + 1x(12G62,5)	11.5	50	54	540	4400	4200	5250	0.27	0.55	0.088	250	10.01
3x95 + 2x50/2 + 1x(12G62,5)	12.8	54	58	580	5300	5700	7125	0.21	0.62	0.084	301	13.59
3x150 + 2x70/2 + 1x(12G62,5)	16.5	63	67	670	7600	9000	11250	0.13	0.73	0.08	404	21.45
3x185 + 2x95/2 + 1x(12G62,5)	18.5	67	72	720	9200	11100	13875	0.11	0.79	0.078	461	26.46

(1) Nominal current carrying capacity for rubber cables laid on a surface, at 30°C ambient temperature (see also VDE 0298-4, Table 15).

## Rated voltage 6/10 kV

Number of cores x cross section	Part number	Conductor diameter max. mm	Outer diameter min. mm	Outer diameter max. mm	Bending radius free moving min. mm	Weight (ca.) kg/km	Permissible tensile force max. N	Dynamic tensile force max. N	Conductor resistance at 20°C max. Ω/km	Nom. operating capacitance μF/km	Inductive Reactance (at 50Hz) Ω/km	Current carrying capacity (1) A	Short Circuit Current (conductor) kA
3x25 + 2x25/2 + 1x(12G62,5)	20091982	6.2	40	43	430	2480	1500	1875	0.78	0.35	0.104	131	3.58
3x35 + 2x25/2 + 1x(12G62,5)	20074719	7.7	42	45	450	2950	2100	2625	0.55	0.39	0.099	162	5.01
3x50 + 2x25/2 + 1x(12G62,5)	20096115	9.3	45	48	480	3480	3000	3750	0.39	0.45	0.094	202	7.15
3x70 + 2x35/2 + 1x(12G62,5)	20092017	11.5	51	55	550	4710	4200	5250	0.27	0.51	0.09	250	10.01
3x95 + 2x50/2 + 1x(12G62,5)	20086347	12.8	55	59	590	5550	5700	7125	0.21	0.58	0.086	301	13.59
3x120 + 2x70/2 + 1x(12G62,5)		14.9	58.5	62.5	625	6700	7200	9000	0.16	0.63	0.084	352	17.16
3x150 + 2x70/2 + 1x(12G62,5)		16.5	63	67	670	7600	9000	11250	0.13	0.69	0.082	404	21.45
3x240 + 2x120/2 + 1x(12G62,5)		21	73	78	780	12400	14400	18000	0.08	1.05	0.08	540	34.32

(1) Nominal current carrying capacity for rubber cables laid on a surface, at 30°C ambient temperature (see also VDE 0298-4, Table 15).

## Rated voltage 8.7/15 kV

Number of cores x cross section	Part number	Conductor diameter max. mm	Outer diameter min. mm	Outer diameter max. mm	Bending radius free moving min. mm	Weight (ca.) kg/km	Permissible tensile force max. N	Dynamic tensile force max. N	Conductor resistance at 20°C max. Ω/km	Nom. operating capacitance μF/km	Inductive Reactance (at 50Hz) Ω/km	Current carrying capacity (1) A	Short Circuit Current (conductor) kA
3x25 + 2x25/2 + 1x(12G62,5)		6.2	42	45	450	2700	1500	1875	0.78	0.3	0.11	139	3.58
3x35 + 2x25/2 + 1x(12G62,5)	20091668	7.7	45	49	490	2960	2100	2625	0.55	0.33	0.105	172	5.01
3x50 + 2x25/2 + 1x(12G62,5)		9.3	50	54	540	3960	3000	3750	0.39	0.37	0.099	215	7.15
3x70 + 2x35/2 + 1x(12G62,5)	20114426	11.5	53	57	570	4760	4200	5250	0.27	0.42	0.094	265	10.01
3x95 + 2x50/2 + 1x(12G62,5)	20153431	12.8	58	62	620	5760	5700	7125	0.21	0.48	0.089	319	13.59
3x120 + 2x70/2 + 1x(12G62,5)		14.9	64	68	680	7265	7200	9000	0.16	0.52	0.087	371	17.16
3x150 + 2x70/2 + 1x(12G62,5)		16.5	68	72	720	8500	9000	11250	0.13	0.57	0.085	428	21.45
3x185 + 2x95/2 + 1x(12G62,5)		18.5	72	77	770	9900	11100	13875	0.11	0.61	0.083	488	26.46

(1) Nominal current carrying capacity for rubber cables laid on a surface, at 30°C ambient temperature (see also VDE 0298-4, Table 15).

Rated voltage 12/20 kV

Number of cores x cross section	Part number	Conductor diameter max. mm	Outer diameter min. mm	Outer diameter max. mm	Bending radius free moving min. mm	Weight (ca.) kg/km	Permissible tensile force max. N	Dynamic tensile force max. N	Conductor resistance at 20°C max. Ω/km	Nom. operating capacitance μF/km	Inductive Reactance (at 50Hz) Ω/km	Current carrying capacity (1) A	Short Circuit Current (conductor) kA
3x25 + 2x25/2 + 1x(12G62,5)	20076107	6.2	45	48	480	2890	1500	1875	0.78	0.24	0.115	139	3.58
3x35 + 2x25/2 + 1x(12G62,5)		7.7	47	50	500	3250	2100	2625	0.55	0.27	0.109	172	5.01
3x50 + 2x25/2 + 1x(12G62,5)		9.3	51	55	550	4050	3000	3750	0.39	0.3	0.103	215	7.15
3x70 + 2x35/2 + 1x(12G62,5)		11.5	56	60	600	4850	4200	5250	0.27	0.34	0.098	265	10.01
3x95 + 2x50/2 + 1x(12G62,5)		12.8	60	64	640	6450	5700	7125	0.21	0.38	0.094	319	13.59
3x120 + 2x70/2 + 1x(12G62,5)		14.9	66	70	700	7700	7200	9000	0.16	0.41	0.091	371	17.16
3x150 + 2x70/2 + 1x(12G62,5)		16.5	69	73	730	8550	9000	11250	0.13	0.45	0.089	428	21.45
3x185 + 2x95/2 + 1x(12G62,5)		18.5	75	79	790	10600	11100	13875	0.11	0.49	0.086	488	26.46

(1) Nominal current carrying capacity for rubber cables laid on a surface, at 30°C ambient temperature (see also VDE 0298-4, Table 15).

# Crane cables



# FLAT MEDIUM VOLTAGE REELING CABLES

	PROTOLON(FL)	PROTOLON (FL) LWL
Designation	(N)TSFLCGEWOEU	(N)TSFLCGEWOEU
Dimension	DIN VDE 0250 part 813	DIN VDE 0250 part 813
Cores	3C + concentric ground	3C + FO + concentric ground
Outer Sheath	Rubber RED	Rubber RED
Approvals		
Tensile Load	15 N/mm <sup>2</sup>	15 N/mm <sup>2</sup>
Speed	120 m/min	120 m/min
Temp. (moving)	-35°C/+80°C	-35°C/+80°C

## PROTOLON(FL) (N)TSFLCGEWOEU

### Medium voltage flat reeling cable



#### Application

Flexible medium voltage reeling cable for high mechanical stresses (e.g. dynamic tensile loads, multiple changes of direction within one plane, running over rollers). Mainly for mobile equipment, e.g. fast-moving container cranes, cranes, large mobile equipment and excavators.

#### Global data

Brand	PROTOLON(FL)
Type designation	(N)TSFLCGEWOEU
Standard	Based on DIN VDE 0250-813

#### Design features

Conductor	Electrolytic copper tinned, finely stranded, class F (refer also to DIN VDE 0295)
Insulation	PROTOLON Special compound based on high-quality EPR (at least 3GI3); improved mechanical and electrical characteristics
Electrical field control	Inner semiconductive layer of EPR, outer semiconductive layer of modified EPR, removable in warm condition
Core identification	Natural coloured insulation with black semiconductive layer
Core arrangement	Parallel core arrangement; earth conductor splitted and concentrically distributed around each core
Sheath system	PROTOFIRM Special compound based on CR, quality at least 5GM5, red colour
Marking	PROTOLON (FL) (N)TSFLCGEWOEU (number of cores)x(cross-section) (rated voltage) (year of manufacture) (serial number)

#### Electrical parameters

Rated voltage	3.6/6 kV	6/10 kV	8.7/15 kV
Max. permissible operating voltage AC	4.2/7.2 kV	6.9/12 kV	10.4/18 kV
Max. permissible operating voltage DC	5.4/10.8 kV	9/18 kV	13.5/27 kV
AC test voltage	11 kV	17 kV	24 kV
Data transmission	A special cable design with fibre-optics can be found in the product range PROTOLON (FL)-LWL		
Current Carrying Capacity description	According to DIN VDE 0298, Part 4 Higher values are permissible in specific cases (please consult the manufacturer).		

#### Chemical parameters

Resistance to oil	Acc. to DIN EN 60811-404 and DIN VDE 0473-811-404, paragraph 10
Weather resistance	Unrestricted use outdoors and indoors, resistant to ozone, UV and moisture
Water resistance	According to HD 2216

#### Thermal parameters

Max. permissible temperature at conductor	90 °C
Max. short circuit temperature of the conductor	250 °C
Ambient temperature for fixed installation	min -50 °C ; max +80 °C
Ambient temperature in fully flexible operation	min -35 °C ; max +80 °C

#### Mechanical parameters

Max. tensile load on the conductor	15 N/mm <sup>2</sup>
Torsional stress	Not allowed
Min. bending radius	Acc. to DIN VDE 0298, Part 3. (Recommendation: applied cable diameter D = 1.5 x height of the flat cable)
Min. distance with S-type directional changes	20 x D (cable diameter)
Travel speed	- Gantry (reeling operation): up to 120 m/min
Additional tests	Reversed bending test, reeling test

### Rated voltage 3.6/6 kV

Number of cores x cross section	Part number	MLFB Number	Conductor diameter max. mm	Min. Height (for flat cable) mm	Max. Height (for flat cable) mm	Min. Width (for flat cable) mm	Max. Width (for flat cable) mm	Bending radius free moving min. mm	Weight (ca.) kg/km	Permissible tensile force max. N	Conductor resistance at 20°C max. Ω/km	Current carrying capacity, reeled in 1 layer (3) A	Short Circuit Current (conductor) kA
3x25+3x25/3E		5DK3...	6.9	24.2	27.2	46.3	68.3	408	2730	1125	0.8	105	3.58
3x35+3x25/3E		5DK3...	8.3	24.7	27.7	65.8	69.8	416	3120	1575	0.57	130	5.01
3x50+3x25/3E	20090795	5DK3471	9.8	27.8	30	71.1	75.1	450	3860	2250	0.39	162	7.15
3x70+3x35/3E		5DK3...	11.4	28.9	31.9	76.8	80.8	479	4730	3150	0.28	200	10.01
3x95+3x50/3E	20008330	5DK3030	13.3	29.2	30.9	75.5	79.5	464	5280	4275	0.21	241	13.59
3x120+3x70/3E	20141934	5DK3454	15.1	35.4	37.4	92.3	97.3	561	7400	5400	0.16	282	17.16

(3) Nominal current carrying capacity for rubber cables reeled in 1 layer, at 30°C ambient temperature (see also technical appendixes).

### Rated voltage 6/10 kV

Number of cores x cross section	Part number	MLFB Number	Conductor diameter max. mm	Min. Height (for flat cable) mm	Max. Height (for flat cable) mm	Min. Width (for flat cable) mm	Max. Width (for flat cable) mm	Bending radius free moving min. mm	Weight (ca.) kg/km	Permissible tensile force max. N	Conductor resistance at 20°C max. Ω/km	Current carrying capacity, reeled in 1 layer (3) A	Short Circuit Current (conductor) kA
3x25+3x25/3E	20135391	5DK4505	6.9	25	27.5	66.7	69.7	413	2860	1125	0.8	105	3.58
3x35+3x25/3E	20008722	5DK4508	8.3	25.5	28.5	68.2	72.2	428	3260	1575	0.57	130	5.01
4x35+4x25/4E	20154113	5DK4514	8.3	25.5	28.5	86.7	91.7	428	4110	2100	0.57	130	5.01
3x50+3x25/3E	20014334	5DK4509	9.8	28.1	31.1	74.6	78.6	467	4030	2250	0.39	162	7.15
3x70+3x35/3E	20040832	5DK4512	11.4	29.7	32.7	79.2	83.2	491	4850	3150	0.28	200	10.01
4x70+4x35/4E	20048375	5DK4513	11.4	29.5	32.5	100.9	105.9	488	6240	4200	0.28	200	10.01
3x95+3x50/3E		5DK4...	13.3	31.7	34.7	84.7	89.7	521	5920	4275	0.21	241	13.59
3x120+3x70/3E		5DK4...	15.1	35.1	38.1	92.9	97.9	572	7420	5400	0.16	282	17.16

(3) Nominal current carrying capacity for rubber cables reeled in 1 layer, at 30°C ambient temperature (see also technical appendixes).



## Rated voltage 8.7/15 kV

Number of cores x cross section	Part number	MLFB Number	Conductor diameter max. mm	Min. Height (for flat cable) mm	Max. Height (for flat cable) mm	Min. Width (for flat cable) mm	Max. Width (for flat cable) mm	Bending radius free moving min. mm	Weight (ca.) kg/km	Permissible tensile force max. N	Conductor resistance at 20°C max. Ω/km	Current carrying capacity, reeled in 1 layer (3) A	Short Circuit Current (conductor) kA
3x25+3x25/3E	20168238	5DK5...	6.9	27.7	30.7	73.3	77.3	461	3390	1125	0.8	111	3.58
3x35+3x25/3E		5DK5...	8.3	28.7	31.7	76.2	80.2	476	3820	1575	0.57	138	5.01
3x50+3x25/E		5DK5...	9.8	30.2	33.2	80.7	84.7	498	4440	2250	0.39	172	7.15
3x70+3x35/3E		5DK5...	11.4	33.3	36.3	87.5	92.5	545	5610	3150	0.28	212	10.01
3x95+3x50/3E		5DK5...	13.3	35.3	38.3	93.5	98.5	575	6700	4275	0.21	255	13.59
3x120+3x70/3E		5DK5...	15.1	37.3	40.3	99.5	104.5	605	8000	5400	0.16	297	17.16

(3) Nominal current carrying capacity for rubber cables reeled in 1 layer, at 30°C ambient temperature (see also technical annexes).



## PROTOLON(FL)-LWL (N)TSFLCGEWOEU

Medium voltage flat reeling cable with fiber-optics



### Application

Flexible medium voltage reeling cable for high mechanical stresses (e.g. dynamic tensile loads, multiple changes of direction within one plane, running over rollers). Mainly for mobile equipment, e.g. fast-moving container cranes, cranes, large mobile equipment and excavators.

### Global data

Brand	PROTOLON(FL) LWL
Type designation	(N)TSFLCGEWOEU
Standard	Based on DIN VDE 0250-813

### Notes on installation

Notes on installation	Preparation of fibre-optics requires special skills and use of elaborate tools. It is therefore recommended that performance of this work is entrusted to our customer service (Factory assembly). Please provide the connection dimensions.
-----------------------	--

### Design features

Conductor	Electrolytic copper tinned, finely stranded, class F (refer also to DIN VDE 0295)																																								
Insulation	PROTOLON Special compound based on high-quality EPR (at least 3GI3); improved mechanical and electrical characteristics																																								
Electrical field control	Inner semiconductive layer of EPR, outer semiconductive layer of modified EPR, removable in warm condition																																								
Core identification	Natural coloured insulation with black semiconductive layer																																								
Optical Fiber	Fibre core diameter: 62.5, 50 or 9µm; diameter across the cladding: 125µm; diameter over the coating: 250µm. Design available with 6,12, 18 or 24 fibres.																																								
	<table> <thead> <tr> <th>Fibre class:</th> <th>G50/125µm</th> <th>G62,5/125µm</th> <th>E9/125µm</th> </tr> <tr> <th>Type:</th> <td>Graded-index fibre</td> <td>Graded-index fibre</td> <td>Monomode fibre</td> </tr> </thead> <tbody> <tr> <td>- Attenuation at 850 nm:</td> <td>&lt;2,8 dB/km</td> <td>&lt;3,3 dB/km</td> <td>-</td> </tr> <tr> <td>- Attenuation at 1310 nm:</td> <td>&lt;0,8 dB/km</td> <td>&lt;0,9 dB/km</td> <td>&lt;0,4 dB/km</td> </tr> <tr> <td>- Attenuation at 1550 nm:</td> <td>-</td> <td>-</td> <td>&lt;0,3 dB/km</td> </tr> <tr> <td>- Bandwidth at 850 nm:</td> <td>&gt;400 MHz</td> <td>&gt;400 MHz</td> <td>-</td> </tr> <tr> <td>- Bandwidth at 1300 nm:</td> <td>&gt;1200 MHz</td> <td>&gt;600 MHz</td> <td>-</td> </tr> <tr> <td>- Numerical aperture:</td> <td>0,2 ± 0,02</td> <td>0,275 ± 0,02</td> <td>0,14 ± 0,02</td> </tr> <tr> <td>- Chromatic dispersion at 1300 nm:</td> <td>-</td> <td>-</td> <td>&lt;3,5 ps/nm km</td> </tr> <tr> <td>- Chromatic dispersion at 1550 nm:</td> <td>-</td> <td>-</td> <td>&lt;3,5 ps/nm km</td> </tr> </tbody> </table>	Fibre class:	G50/125µm	G62,5/125µm	E9/125µm	Type:	Graded-index fibre	Graded-index fibre	Monomode fibre	- Attenuation at 850 nm:	<2,8 dB/km	<3,3 dB/km	-	- Attenuation at 1310 nm:	<0,8 dB/km	<0,9 dB/km	<0,4 dB/km	- Attenuation at 1550 nm:	-	-	<0,3 dB/km	- Bandwidth at 850 nm:	>400 MHz	>400 MHz	-	- Bandwidth at 1300 nm:	>1200 MHz	>600 MHz	-	- Numerical aperture:	0,2 ± 0,02	0,275 ± 0,02	0,14 ± 0,02	- Chromatic dispersion at 1300 nm:	-	-	<3,5 ps/nm km	- Chromatic dispersion at 1550 nm:	-	-	<3,5 ps/nm km
Fibre class:	G50/125µm	G62,5/125µm	E9/125µm																																						
Type:	Graded-index fibre	Graded-index fibre	Monomode fibre																																						
- Attenuation at 850 nm:	<2,8 dB/km	<3,3 dB/km	-																																						
- Attenuation at 1310 nm:	<0,8 dB/km	<0,9 dB/km	<0,4 dB/km																																						
- Attenuation at 1550 nm:	-	-	<0,3 dB/km																																						
- Bandwidth at 850 nm:	>400 MHz	>400 MHz	-																																						
- Bandwidth at 1300 nm:	>1200 MHz	>600 MHz	-																																						
- Numerical aperture:	0,2 ± 0,02	0,275 ± 0,02	0,14 ± 0,02																																						
- Chromatic dispersion at 1300 nm:	-	-	<3,5 ps/nm km																																						
- Chromatic dispersion at 1550 nm:	-	-	<3,5 ps/nm km																																						
Fiber coding	Specially developed color code for identification of the individual fibres																																								
Fiber covering	Hollow core with filling compound, Basic material: ETFE, Compound: 7YI 1, Natural color																																								
Core arrangement	Parallel core arrangement; earth conductor splitted and concentrically distributed around each core. Optical Element: six tubes, laid up around a central support element, with one, two or three optical fibers in each.																																								
Sheath system	PROTOFIRM Special compound based on CR, quality at least 5GM5, red colour																																								
Marking	PROTOLON (FL) LWL (N)TSFLCGEWOEU (number of cores)x(cross-section) (rated voltage) (year of manufacture) (serial number)																																								

### Electrical parameters

Rated voltage	3.6/6 kV	6/10 kV	8.7/15 kV
Max. permissible operating voltage AC	4.2/7.2 kV	6.9/12 kV	10.4/18 kV
Max. permissible operating voltage DC	5.4/10.8 kV	9/18 kV	13.5/27 kV
AC test voltage	11 kV	17 kV	24 kV
Data transmission	Special design with fibre-optics for trouble free data transmission at high data rates		
Current Carrying Capacity description	Acc. to DIN VDE 0298, Part 4 Higher values are permissible in specific cases (please consult the manufacturer).		

### Chemical parameters

Resistance to oil	Acc. to DIN EN 60811-404 and DIN VDE 0473-811-404, paragraph 10
Weather resistance	Unrestricted use outdoors and indoors, resistant to ozone, UV and moisture
Water resistance	Acc. to HD 2216

### Thermal parameters

Max. permissible temperature at conductor	90 °C
Max. short circuit temperature of the conductor	250 °C
Ambient temperature for fixed installation	min -50 °C ; max +80 °C
Ambient temperature in fully flexible operation	min -35 °C ; max +80 °C

### Mechanical parameters

Max. tensile load on the conductor	15 N/mm <sup>2</sup>
Torsional stress	Not allowed
Min. bending radius	Acc. to DIN VDE 0298, Part 3. (Recommendation: applied cable diameter D = 1.5 x height of the flat cable)
Min. distance with S-type directional changes	20 x D (cable diameter)
Travel speed	- Gantry (reeling operation): up to 120 m/min
Additional tests	Reversed bending test, reeling test

### Rated voltage 3.6/6 kV

Number of cores x cross section	Part number	MLFB Number	Conductor diameter max. mm	Min. Height (for flat cable) mm	Max. Height (for flat cable) mm	Min. Width (for flat cable) mm	Max. Width (for flat cable) mm	Bending radius free moving min. mm	Weight (ca.) kg/km	Permissible tensile force max. N	Conductor resistance at 20°C max. Ω/km	Current carrying capacity, reeled in 1 layer (3) A	Short Circuit Current (conductor) kA
3x35+4x25/4E +1x(6G62,5)		5DK3...	8.3	24.5	27.5	83.5	88.5	413	3700	1575	0.57	130	5.01
3x50+4x25/4E +1x(6G62,5)	20015923	5DK3035	9.8	23.9	25.9	79.1	84.1	389	3890	2250	0.39	162	7.15
3x70+4x35/4E +1x(6G62,5)		5DK3...	11.4	28.7	31.7	97.7	102.7	476	5590	3150	0.28	200	10.01
3x95+4x50/4E +1x(6G62,5)		5DK3...	13.3	30.6	33.6	105.3	110.3	504	6720	4275	0.21	241	13.59

(3) Nominal current carrying capacity for rubber cables reeled in 1 layer, at 30°C ambient temperature (see also technical appendixes). Design with 12, 18 or 24 fibers and/or G50 or E9 types available upon request.

Rated voltage 6/10 kV

Number of cores x cross section	Part number	MLFB Number	Conductor diameter max. mm	Min. Height (for flat cable) mm	Max. Height (for flat cable) mm	Min. Width (for flat cable) mm	Max. Width (for flat cable) mm	Bending radius free moving min. mm	Weight (ca.) kg/km	Permissible tensile force max. N	Conductor resistance at 20°C max. Ω/km	Current carrying capacity, reeled in 1 layer (3) A	Short Circuit Current (conductor) kA
3x35+4x25/4E +1x(6G62,5)		5DK4254	8.3	25.3	28.3	86.7	91.7	425	3910	1575	0.57	130	5.01
3x50+4x25/4E +1x(6G62,5)	20024635	5DK4253	9.8	27.8	30.8	94.1	99.1	462	4810	2250	0.39	162	7.15
3x70+4x35/4E +1x(6G62,5)		5DK4...	11.4	29.5	32.5	100.9	105.9	488	5800	3150	0.28	200	10.01
3x95+4x50/4E +1x(6G62,5)	20165662	5DK4...	13.3	31.4	34.4	108.5	113.5	516	6940	4275	0.21	241	13.59

(3) Nominal current carrying capacity for rubber cables reeled in 1 layer, at 30°C ambient temperature (see also technical appendixes). Design with 12, 18 or 24 fibers and/or G50 or E9 types available upon request.

Rated voltage 8.7/15 kV

Number of cores x cross section	Part number	MLFB Number	Conductor diameter max. mm	Min. Height (for flat cable) mm	Max. Height (for flat cable) mm	Min. Width (for flat cable) mm	Max. Width (for flat cable) mm	Bending radius free moving min. mm	Weight (ca.) kg/km	Permissible tensile force max. N	Conductor resistance at 20°C max. Ω/km	Current carrying capacity, reeled in 1 layer (3) A	Short Circuit Current (conductor) kA
3x35+4x25/4E +1x(6G62,5)	20004696	5DK5435	8.3	29.3	32.3	96.9	101.9	485	4630	1575	0.57	138	5.01
3x50+4x25/4E +1x(6G62,5)	20168452	5DK5...	9.8	30	33	102.9	107.9	495	5400	2250	0.39	172	7.15
3x70+4x35/4E +1x(6G62,5)		5DK5...	11.4	31.7	33.7	109.7	114.7	506	6460	3150	0.28	212	10.01

(3) Nominal current carrying capacity for rubber cables reeled in 1 layer, at 30°C ambient temperature (see also technical appendixes). Design with 12, 18 or 24 fibers and/or G50 or E9 types available upon request.



# Crane cables



## Technical Annex

### Application

Flexible electric cables for cranes and material handling equipment are to be selected in accordance with the application for which they are intended (cable guidance system) and in accordance with the expected operation and installation conditions.

If necessary, the cables are to be protected against mechanical, thermal or chemical influences and also against the penetration of moisture from the ends of the cables.

Flexible electric cables for cranes and material handling equipment must not be installed in the ground. Ducts through fire barriers in the form of sand, etc. or temporary covering with soil, sand or similar material, e.g. on construction sites, do not count as being in the ground.

In general, fixing materials must not damage the flexible electric cables.

Flexible electric cables shall not be relieved of tension when they are connected to mobile equipment (cranes, material handling equipment) and must be secured to prevent them from twisting, sharp bending and axial compression. The sheaths of the flexible electric cables must not be damaged at the entries or by stress-relief devices.

### Type / Trademark

#### Trademarks used for flexible electric cables for cranes and material handling equipment

##### Flexible cables

<b>CORDAFLEX®</b>	Tough rubber-sheathed reeling cable
<b>EASYFLEX®</b>	EVA sheathed cable for spring-reeling
<b>TROMMELFLEX®</b>	Rubber-, Polyurethane-sheathed reeling cable
<b>SPREADERFLEX®</b>	Special cable for gravity-fed collector basket operation
<b>RONDOFLEX®</b>	Round rubber-sheathed festoon cable also suitable for simple reeling
<b>FESTOONFLEX®</b>	Round polyurethane-sheathed festoon cable
<b>PLANOFLEX®</b>	Flat rubber-sheathed festoon cable
<b>OPTOFLEX®</b>	Rubber-sheathed flexible fibre-optic cable
<b>PROTOLON®</b>	Medium-voltage reeling cable
<b>TENAX®</b>	Medium-voltage reeling cable

##### Special compounds

<b>PROTOFIRM®</b>	Sheathing compound PCP used in <b>CORDAFLEX®</b> , <b>PROTOLON®</b> . Compound with special resistance to abrasion and tearing, 5GM5 quality
<b>PROTOLON®</b>	Insulating compound EPR used in <b>CORDAFLEX®</b> , <b>PROTOLON®</b> . Rubber compound with excellent electrical properties, resistant to heat and weather



# Crane cables

## Type / Type designation

The type designates a group of flexible electric cables which have the same design features and which are intended for a specific range of technical applications.

The type designation is a letter combination according to DIN VDE, which describes the type in coded form<sup>1)</sup>.

<b>(N)SHTÖU</b>	Tough rubber-sheathed flexible reeling cable, CORDAFLEX and TROMMELFLEX
<b>(N)7YRDGÖU</b>	EVA sheathed cable for spring-reeling, EASYFLEX
<b>D12Y11YU11Y</b>	Polyurethane-sheathed reeling cable, TROMMELFLEX
<b>D12YST11YU11Y</b>	Polyurethane-sheathed reeling cable for vertical application, SPREADER REEL
<b>3GSLTÖ</b>	Special cable for gravity-fed collector basket operation, SPREADERFLEX
<b>(N)GRDGÖU</b>	Round rubber-sheathed flexible festoon cable also suitable for simple reeling, RONDOfLEX and RONDOfLEX (CHAIN)
<b>(N)GRDGCGÖU</b>	Round screened rubber-sheathed flexible festoon cable also suitable for simple reeling, RONDOfLEX(C)-FC
<b>D12Y11Y</b>	Round polyurethane-sheathed flexible festoon cable, FESTOONFLEX
<b>D12YC11Y</b>	Round screened polyurethane-sheathed flexible festoon cable, FESTOONFLEX C
<b>NGFLGÖU</b>	Flat rubber-sheathed flexible festoon cable, PLANOfLEX
<b>M(StD)HÖU</b>	Flat screened rubber-sheathed flexible festoon cable
<b>(N)TSCGEWÖU</b>	Round medium-voltage reeling cables PROTOLON and TENAX, 6 to 20 kV
<b>(N)TSKCGEWÖU</b>	Round medium-voltage reeling cables with cradle separator PROTOLON, 6 to 20 kV
<b>(N)TSFLCGEWÖU</b>	Flat medium-voltage reeling cables PROTOLON, 6 to 20 kV

The type designation can be deciphered as follows:

<b>..C..</b>	Conducting metal casing over the stranded cores or between the inner and outer sheath (shield)
<b>(C)</b>	Additional information about the shield for the conductor cross-sections, e.g. 12 x 1 (C) which means 1 mm <sup>2</sup> individually shielded or 6 x (2 x 1)C which means 2 x 1 mm <sup>2</sup> twisted and shielded pairs
<b>..CE..</b>	Conducting metal casing over the insulation of the outer conductors
<b>..CG..</b>	Conducting non-metal casing over the stranded cores or between the inner and outer sheath (shield)
<b>..CGE..</b>	Conducting non-metal casing over the insulation of the outer conductors
<b>D</b>	Based on internal specification
<b>FL</b>	Flat cable
<b>FM</b>	Telecommunication lines within the cable
<b>FO</b>	Fibre-optic (German LWL)

<b>G</b>	Rubber compound
<b>HS</b>	High-voltage (HV)
<b>-J</b>	Additional information about the type: With green/yellow marked core
<b>K</b>	Rubber cross in the centre of the cable or (K) as a supplement to the trademark, e.g. TROMMELFLEX(K)
<b>KON</b>	Concentric protective conductor between the inner and outer sheath or concentric control/ monitoring conductor
<b>LWL</b>	Fibre-optic (FO)
<b>(M)</b>	Suffix to the trademark, e.g. OPTOFLEX (M) for Mining
<b>MS</b>	Medium-voltage (MV)
<b>N</b>	Design according to the corresponding standard
<b>(N)</b>	Based on standard
<b>-O</b>	Additional information about the type - without green/yellow marked core
<b>Ö<sup>1)</sup></b>	Oil-resistant outer sheath (according to DIN EN 60811-404; VDE 0473-811-404) (OE)
<b>RD</b>	Round cable
<b>...SHT...</b>	1 kV reeling cable
<b>..SL..</b>	Control cable
<b>(SMK)</b>	Flexible cables for extremely high mechanical stress, trademarks CORDAFLEX (SMK) and PROTOLON (SMK)
<b>ST</b>	Control cores within the cables or central support element for SPREADER REEL
<b>..T..</b>	Support element
<b>..TS..</b>	Reeling cable
<b>U</b>	Flame-retardant outer sheath (according to DIN VDE 0472, Part 804) „non-inflammable“
<b>ÜL<sup>1)</sup></b>	Monitoring conductor within the cable (UEL)
<b>..W..</b>	Weather resistant
<b>Y</b>	PVC compound
<b>Z</b>	Printed numbers
<b>11Y</b>	PUR compound
<b>12Y</b>	PETP compound
<b>/3</b>	Protectiv-earth conductor uniformly distributed in the three interstices
<b>/3E</b>	Protective-earth conductor uniformly distributed over the insulation of the outer conductor or around other elements

1) The German characters „Ö“ and „Ü“ are transformed into the international „OE“ and „UE“, respectively

## Approvals / Standards

Flexible electric cables for cranes and material handling equipment have to be able to cope with the expected operation and installation conditions. Details are given in the application and installation guidelines. In addition, flexible electric cables for cranes and material handling equipment are described with regard to designs and test as laid down in national and international standards (design regulations).

### Application and installation guidelines

<b>DIN VDE 0298, Part 3</b>	Application of cables and flexible cords in power installations - General information on cables
<b>DIN VDE 0298, Part 4</b>	Application of cables and flexible cords in power installations - Recommended values for current-carrying capacity of cables
<b>DIN VDE 0100, Part 726</b>	Erection of power installations with rated voltages up to 1000 V - Cranes
<b>DIN VDE 0101</b>	Erection of power installations with rated voltages above 1 kV
<b>DIN VDE 0118</b>	Specification for the erection of electrical installations in underground mines
<b>DIN VDE 0168</b>	Specification for the erection of electrical installations in open-cast mines, quarries and similar works
<b>EN 81, Part 1</b>	Safety regulations for the construction and installation of passenger lifts, goods lifts and service lifts

### Design regulations

The summary in the following table shows all the design regulations/standards, according to which the flexible electric cables for cranes and material handling equipment are designed and manufactured. The following distinctions are made between national and international regulations:

#### National standard

**DIN VDE** (DIN = German Standards Institute; VDE = Association of German Electrical Engineers)  
Germany is the only country which has issued special design regulations for flexible electric cables for cranes and material handling equipment. The tough rubber-sheathed flexible reeling cables **CORDAFLEX** and **TROMMELFLEX NSHTÖU**, the MV reeling cables **PROTOLON** and **TENAX NTS.WÖU** and the flat rubber-sheathed flexible cables **PLANOFLEX NGFLGÖU** are described and standardized in DIN VDE 0250. This set of standards has found recognition in Europe and in many countries outside Europe and is accepted as or specified as „state of the art“.

The new generation of reeling cables (described in this catalog) generally conforms to these standards, however, they deviate in a number of points, where it is necessary to achieve an enhanced feature profile. Efforts are being made to have these modifications incorporated in the relevant standards.

No such design regulations exist for **RONDOFLEX**, **SPREADERFLEX**, **OPTOFLEX**, **FESTOONFLEX**, **TROMMELFLEX PUR**. These are Prysmian special cables, the design of which is based on existing design regulations or general regulations of DIN VDE.

### International standard

International standards have been taken into account for all our cables where this was possible.

For use on an international level, some design features of flexible electric cables for cranes and material handling equipment covered by DIN VDE are also listed or certified in line with **UL** or **MSHA**.

**UL** = Underwriters Laboratories Inc.

UL is an approval and standardization institute in the USA. The UL standard is requested in North America and also to some extent in the Far East.

**MSHA** = Mine Safety and Health Administration

The MSHA listing was specially issued for the corresponding electric cables by the „Deep Mine Safety“ office at Harrisburg, USA. The flame-retardant behaviour of the cables was tested.

Flexible cables	Type	German stand. DIN VDE	International stand.
CORDAFLEX (SMK)	(N)SHTÖU	Based on DIN VDE 0250-814; VDE Reg. Nr. 7519	Gost-R
EASYFLEX	(N)7YRDGÖU	-	
TROMMELFLEX PUR-HF	D12Y11YU11Y	-	
TROMMELFLEX KSM-S	(N)SHTÖU	Based on DIN VDE 0250-814	
TROMMELFLEX (K)	NSHTÖU	DIN VDE 0250-814	
CORDAFLEX (SMK)-V	(N)SHTÖU	Based on DIN VDE 0250-814	Gost-R
SPREADER REEL PUR-HF	D12YST11YU11Y	-	
SPREADERFLEX	3GSLTÖ	Based on DIN VDE 0250	Gost-R
RONDOFLEX	(N)GRDGÖU	Based on DIN VDE 0250-814; VDE Reg. Nr. 7841	Gost-R
RONDOFLEX(C)-FC	(N)GRDGCGÖU	Based on DIN VDE 0250-814; VDE Reg. Nr. 7841	Gost-R
RONDOFLEX(CHAIN)	(N)GRDGÖU	Based on DIN VDE 0250-814	Gost-R
FESTOONFLEX PUR-HF	D12Y11Y	-	
FESTOONFLEX C-PUR-HF	D12YC11Y	-	
PLANOFLEX	NGFLGÖU	DIN VDE 0250-809	UL File R 113313, Gost-R
M(StD)HÖU	M(StD)HÖU	Based on DIN VDE 0250-809	UL Style 4540
OPTOFLEX		Based on DIN VDE 0888 and DIN VDE 0168	Based on FDDI, ISO/IEC 9314 (Part3)
PROTOLON (SMK)	(N)TSCGEWÖU	Based on DIN VDE 0250-813	Gost-R
PROTOLON (SMK) LWL	(N)TSKCGEWÖU	Based on DIN VDE 0250-813	Gost-R
TENAX TTS/LWL	(N)TSCGEWÖU	Based on DIN VDE 0250-813	
PROTOLON (FL)/LWL	(N)TSFLCGEWÖU	Based on DIN VDE 0250-813	

# Crane cables

## Installation of reeling cables

To ensure proper and trouble-free operation of flexible electric reeling cables for cranes and material handling equipment such as PROTOLON, TENAX, CORDAFLEX and TROMMELFLEX, it is necessary to observe certain rules for cable attachment (installation on the operating drum).

The cable can be directly wound from the supply drum to the operating drum. Pulling off the drum and laying stretched on the ground or „dekinking“ prior to taking up the cable on the operating drum should not be carried out.

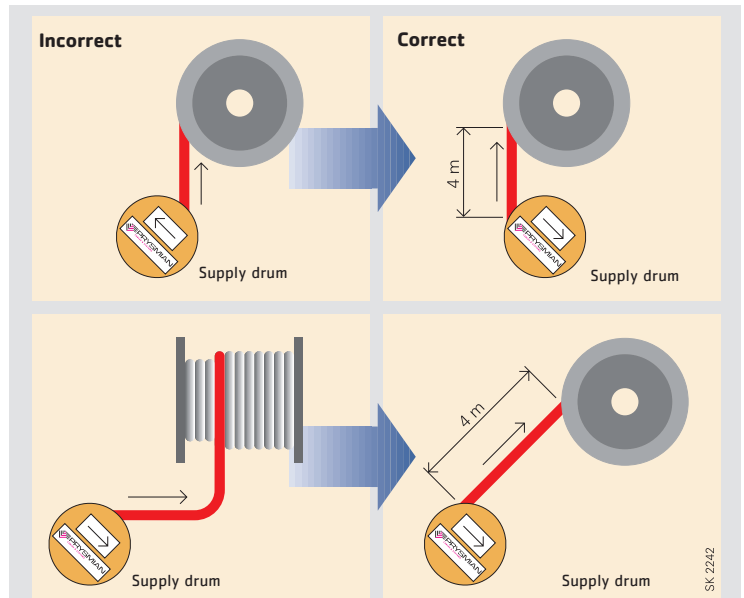

The direction of lay employed in manufacture of power cables is always left-hand (S-type). It is therefore recommended that the start of the winding of reeling power cables on cylindrical reels should always be at the left side.

This measure ensures a clean and correct winding pattern, even when no guidance helical slot has been provided on the reel body.

The direction of lay employed in manufacture of control cables is always right-hand, for this reason such cables should be operated with the start of the winding at the right side.

**Never:** draw the cable over the flange „head over heels“, because this would cause 360° torsion with each loop.

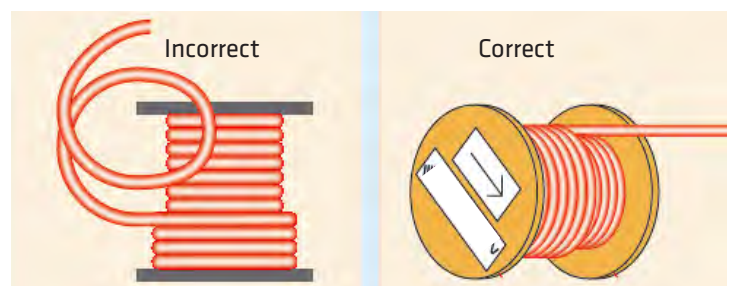
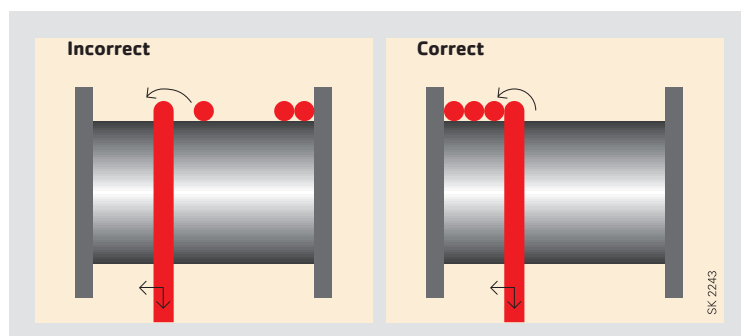

Special installation instructions for other applications (e.g. festoon cables, spreader cable for basket operation) are available upon request.

## Centre feeding point

In many installations, e.g. bunkering equipment, the power infeed point is located at the centre of the guideway. The flexible electric reeling cables such as PROTOLON, TENAX, CORDAFLEX and TROMMELFLEX are normally connected through under-floor infeeds (see picture).

In order to achieve effective strain relief in conjunction with cable-wear minimizing deflection from the infeed point, we recommend the use of underfloor infeeds (see figure below). It is important that the specified bending radius is maintained and that the cable is fastened at the compensation cylinder by means of a clip, which, however, should be attached only after the 2<sup>nd</sup> winding.



- 1 Flexible electric reeling cable
- 2 Entry bell for infeed
- 3 Cable tray
- 4 Cable straight-through joint
- 5 Buried cable
- 6 Compensation cylinder
- 7 Cable clip (large area design)
- d Max. cable diameter
- $R_{min}$  Bending radius of entry bell and bending radius of compensation cylinder

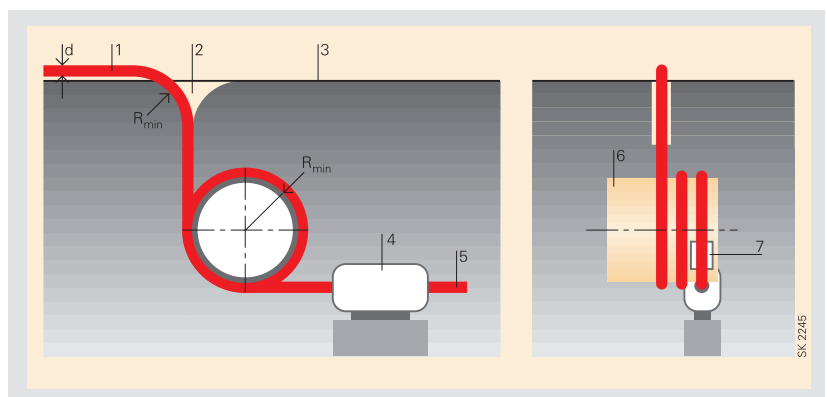

### Min. permissible bending radius as a function of the cable diameter

Flexible cables	CORDAFLEX, TROMMELFLEX				PROTOLON, TENAX
Rated voltage $U_o/U$	Up to 0.6/1kV				Above 0.6/1kV
d in mm	Up to 8	Above 8 to 12	Above 12 to 20	Above 20	10 x d
$R_{min}$	3 x d	4 x d	5 x d	5 x d	

## Electrical parameters

### Voltages

For the rated, operating and test voltages of cables, the definitions given in DIN VDE 0298, Part 3, apply. Some of these are mentioned in the table below.

AC = alternating current

DC = direct current

### Rated voltage

The rated voltage of an insulated electric cable is the voltage which is used as the basis for the design and the testing of the cable with regard to its electrical characteristics.

The rated voltage is expressed by the two values of power frequency voltage  $U_0/U$  in V.

$U_0$  = rms value between one conductor and „Earth“

$U$  = rms value between two conductors of a multi-core cable or of a system of single-core cables

In a system with AC voltage, the rated voltage of a cable must be at least equal to the rated voltage of the system for which it is used. This requirement applies both to the value  $U_0$  and the value  $U$ .

In a system with DC voltage, its rated voltage must not be more than 1.5 times the value of the rated voltage of the cable.

### Operating voltage

The operating voltage is the voltage applied between the conductors and earth of a power installation with respect to time and place with trouble-free operation.

- Cables with a rated voltage  $U_0/U$  up to 0.6/1 kV  
These cables are suitable for use in three-phase AC, single-phase AC and DC installations, the maximum continuously permissible operating voltage of which does not exceed the rated voltage of the cables by more than  
10% for cables with a rated voltage  $U_0/U$  up to and including 450/750 V  
20% for cables with a rated voltage  $U_0/U = 0.6/1$  kV
- Cables with a rated voltage  $U_0/U$  greater than 0.6/1 kV  
These cables are suitable for use in three-phase and single-phase AC installations, the maximum operating voltage of which does not exceed the rated voltage of the cable by more than 20%
- Cables in DC installations  
If the cables are used in DC installations, the continuously permissible DC operating voltage between the conductors must not exceed 1.5 times the value of the permissible AC operating voltage. In single-phase earthed DC installations this value should be multiplied by a factor of 0.5.

## Test voltage

Regarding the test voltage of flexible cables, the values given in the corresponding parts of DIN VDE 0250 apply. If the relevant shield is missing, as for example with CORDAFLEX and PLANOFLEX cables, „core against core“ is tested in appropriate combinations. The values have to be considered as AC test voltages (unless stated otherwise) for single-phase testing, i.e. the AC test voltage is applied between the core and the corresponding shielding (e.g. semiconductive layer, earth conductor, shield). Telecommunication cores (pairs) and other shielded pairs (e.g. 2x1C) are tested „core against core“ and „core against shield“ whereby the test voltages are correspondingly different. With single-core cables without shielding, the corresponding opposite pole is a water bath.

Flexible cables	Rated voltage	Max. permissible operating voltage			Test voltage applied to the complete cable			
		in AC systems	in DC systems		Power cores	Control cores	Pilot cores	Twisted pairs
	U <sub>0</sub> /U	U <sub>0</sub> /U	unearthed U kV	single-phase earthed U kV				
CORDAFLEX	0.6/1 kV	0.7/1.2 kV	1.8	0.9	3.5	3.5		
EASYFLEX	0.6/1 kV	0.7/1.2 kV	1.8	0.9	3.5	3.5		
TROMMELFLEX	0.6/1 kV	0.7/1.2 kV	1.8	0.9	4	2		
SPREADER REEL	0.6/1 kV	0.7/1.2 kV	1.8	0.9	4	2		
SPREADERFLEX	0.6/1 kV	0.7/1.2 kV	1.8	0.9	3.5	3.5		
RONDOFLEX	0.6/1 kV	0.7/1.2 kV	1.8	0.9	3.5	2.5		
FESTOONFLEX	0.6/1 kV	0.7/1.2 kV	1.8	0.9	4	2		
PLANOFLEX	300/500 V	0.7/1.2 kV	1.8	0.9	2.5	2		
M(Std)HÖU	0.6/1 kV	0.7/1.2 kV	1.8	0.9	2.5	2		
PROTOLON TENAX	1.8/3 kV	2.1/3.6 kV	5.4	2.7	6	2	2	1
	3.6/6 kV	4.2/7.2 kV	10.8	5.4	11	2	2	1
	6/10 kV	6.9/12 kV	18	8	17	2	2	1
	8.7/15 kV	10.4/18 kV	27	14	24	2	2	1
	12/20 kV	13.9/24 kV	36	18	29	2	2	1
	14/25 kV	17.3/30 kV	45	23	36	2	2	1
	18/30 kV	20.8/36 kV	54	27	43	2	2	1
20/35 kV	24.3/42 kV	63	32	50	2	2	1	



# Crane cables

## Electrical parameters

### Current-carrying capacity

If, after all selection criteria have been taken into account, the type of flexible electric cable to be used for cranes and material handling equipment has been decided on, the necessary cross-section of the conductor can be determined either from the current to be transmitted or from the power.

Installation conditions (stretched laying, suspended freely in the air, reeled), variations in ambient temperature, grouping, type of operation (continuous duty, intermittent periodic duty) and the use of multi-core cables shall be taken into account.

The table below is valid for continuous duty at 30°C ambient temperature and three loaded cores, rubber-insulated.

### Rubber-insulated

#### LV and MV reeling cables up to 10kV

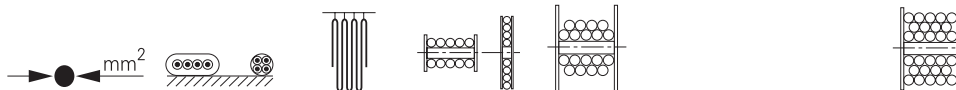

Cross-section mm <sup>2</sup>	Stretched laying	Suspended freely in air	Reeled in						
			1 layer	2 layers	3 layers <sup>1)</sup>	4 layers	5 layers	6 layers	7 layers
	A	A	A	A	A	A	A	A	A
	Factor 1	1.05	0.8	0.61	0.49	0.42	0.38	0.27	0.22
1	18	19	14	11	9	8	7	5	4
1.5	23	24	18	14	11	10	9	6	5
2.5	30	32	24	18	15	13	11	8	7
4	41	43	33	25	20	17	16	11	9
6	53	56	42	32	26	22	20	14	12
10	74	78	59	45	36	31	28	20	16
16	99	104	79	60	49	42	38	27	22
25	131	138	105	80	64	55	50	35	29
35	162	170	130	99	79	68	62	44	36
50	202	212	162	123	99	85	78	55	44
70	250	263	200	153	123	105	95	68	55
95	301	316	241	184	147	126	114	81	66
120	352	370	282	215	172	148	134	95	77
150	404	424	323	246	198	170	154	109	89
185	461	484	369	281	226	194	175	124	101
240	540	567	432	329	265	227	205	146	119
300	620	651	496	378	304	260	236	167	136

1) The reduction factor is also valid for flat reeling cables (spirally)

## Rubber-insulated

### MV reeling cables above 10 kV

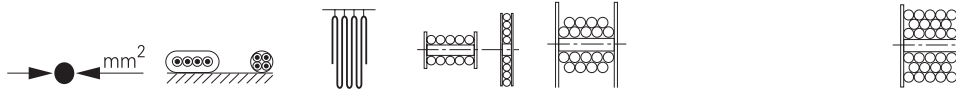

Cross-section mm <sup>2</sup>	Stretched laying A Factor 1	Suspended freely in air A 1.05	Reeled in						
			1 layer A 0.8	2 layers A 0.61	3 layers <sup>1)</sup> A 0.49	4 layers A 0.42	5 layers A 0.38	6 layers A 0.27	7 layers A 0.22
16	105		84	64	51	44	40	28	23
25	139		111	85	68	58	53	38	31
35	172		138	105	84	72	65	46	38
50	216		172	131	105	90	82	58	47
70	265		212	162	130	111	101	72	58
95	319		255	195	156	134	121	86	70
120	371		297	226	182	156	141	100	82
150	428		342	261	210	180	163	116	94
185	488		390	298	239	205	185	132	107
240	574		459	350	281	241	218	155	126
300	660		528	403	323	277	251	178	145

1) The reduction factor is also valid for flat reeling cables (spirally)

# Crane cables

## Electrical parameters

### De-rating factors

The de-rating factors take into account the installation and operating conditions, such as temperature, grouping, intermittent periodic duty and the number of simultaneously loaded cores. They shall be used for determining the current-carrying capacity in accordance with the tables on page 128/129.

### De-rating factors for varying ambient temperatures

Ambient temperature °C															
10	15	20	25	30	35	40	45	50	55	60	65	70	75	80	85
1.15	1.12	1.08	1.04	1.0	0.96	0.91	0.87	0.82	0.76	0.71	0.65	0.58	0.50	0.41	0.29

### De-rating factors for grouping

Arrangement		Number of multi-core cables or number of single or three-phase circuits made up of single-core cables (2 or 3 loaded conductors)															
		1	2	3	4	5	6	7	8	9	10	12	14	16	18	20	
Bunched directly at the wall, on the floor, in conduit or ducts, on or in the wall		1.0	0.8	0.7	0.65	0.6	0.57	0.54	0.52	0.5	0.48	0.45	0.43	0.41	0.39	0.38	
Single layer on the wall or floor, touching		1.0	0.85	0.79	0.75	0.73	0.72	0.72	0.71	0.70	0.70	0.70	0.70	0.70	0.70	0.70	
Single layer on the wall or floor, spaced with a clearance of 1 x cable diameter between adjacent cables		1.0	0.94	0.9	0.9	0.9	0.9	0.9	0.9	0.9	0.9	0.9	0.9	0.9	0.9	0.9	
Single layer under ceiling, touching		0.95	0.81	0.72	0.68	0.66	0.64	0.63	0.62	0.61	0.61	0.61	0.61	0.61	0.61	0.61	
Single layer under ceiling, spaced with a clearance of 1 x cable diameter between adjacent cables		0.95	0.85	0.85	0.85	0.85	0.85	0.85	0.85	0.85	0.85	0.85	0.85	0.85	0.85	0.85	

### De-rating factors for intermittent periodic duty

Ambient temperature	30°C	Nominal cross-section mm <sup>2</sup>	Duty factor ED %			
			60	40	25	15
Duty cycle	10 min	0.75	1.00	1.00	1.00	1.00
		1	1.00	1.00	1.00	1.00
		1.5	1.00	1.00	1.00	1.00
		2.5	1.00	1.00	1.04	1.07
		4	1.00	1.03	1.05	1.19
		6	1.00	1.04	1.13	1.27
		10	1.03	1.09	1.21	1.44
		16	1.07	1.16	1.34	1.62
		25	1.10	1.23	1.46	1.79
		35	1.13	1.28	1.53	1.90
		50	1.16	1.34	1.62	2.03
		70	1.18	1.38	1.69	2.13
		95	1.20	1.42	1.74	2.21
		120	1.21	1.44	1.78	2.26
		150	1.22	1.46	1.81	2.30
		185	1.23	1.48	1.82	2.32
		240	1.23	1.49	1.85	2.36
300	1.23	1.50	1.87	2.39		

### De-rating factors for multi-core cables with conductor cross-sections up to 10mm<sup>2</sup>

Number of loaded cores	De-rating factors
5	0.75
7	0.65
10	0.55
12	0.53
14	0.50
18	0.44
19	0.45
24	0.40
30	0.37
36	0.36
40	0.35
42	0.35
61	0.30

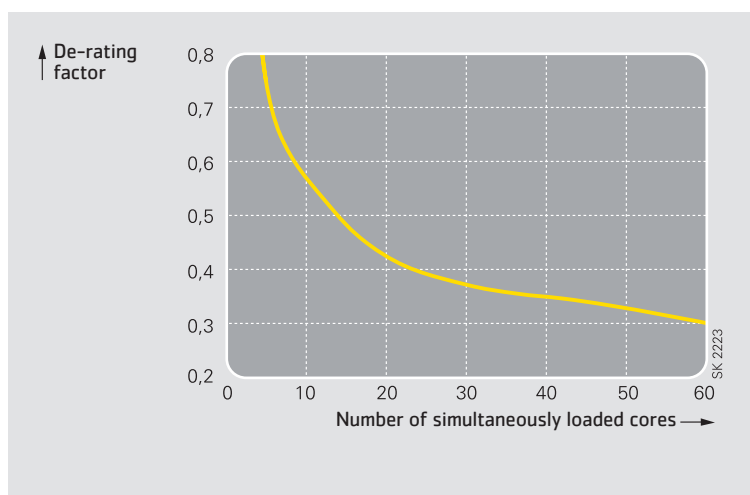

## Electrical parameters

**Permissible short-circuit current at max. permissible short-circuit temperatures of the conductor surface and for a fault duration  $t_{kr} = 1$  s**

Cross-section mm <sup>2</sup>	1	1.5	2.5	4	6	10	16	25	35	50	70	95	120	150	185	240	300
Short-circuit current (kA)	0.143	0.215	0.358	0.572	0.858	1.43	2.29	3.58	5.01	7.15	10.01	13.6	17.16	21.45	26.46	34.32	42.9

The short-circuit current-carrying capacity  $I_{thz}$  for a short-circuit duration  $t_k$  deviating from  $t_{kr} = 1$  s, is:

$$I_{thz} = I_{thr} \cdot \sqrt{\frac{t_{kr}}{t_k}}$$

### Electromagnetic compatibility

Electromagnetic compatibility is the capability of an electrical or electronic device to function correctly in its electromagnetic environment and not to cause interference to the environment to an impermissible degree.

This matter is of immediate concern for all those engaged in planning and manufacturing electrical equipment and installations. On the one hand, the EMC legislation introduced in Germany from 1.1.1996, and, on the other hand, the high processing speed and transmission rates of modern electronics necessitate increased attention being paid to the question of the influence of transmitted and received interference. Non-observance of the currently valid EMC standards can lead to imposition of fines.

### Standards

Standards, which directly address the question of cable construction or cable characteristics, do not exist. Whether a cable causes interference or not, is solely dependent on the manner in which it is used. From the point of view of the user, those standards, which specify limit values for permissible levels of interference, are relevant. These refer to equipment, plants or other electrical installations and thus refer indirectly to the cables. Those responsible for erection or manufacture thereof must confirm or prove that their equipment meets the EMC requirements.

The currently valid standards and regulations, which are important for use of insulated cables, are listed in the tables on page 128/129.

### Criteria for EMC cable selection

Selection of the most suitable cable application/connection at site from the point of view of EMC can be carried out employing the criteria listed below:

- Use of a cable shield with low transfer impedance
- Symmetrical design and operation of the cable
- Choice of suitable materials by reason of the higher voltage stress of the insulation by reflections at frequencies above 100 MHz; low loss figure
- Large clearance between the interference source and the interference sink (power cables layed spatially separated from the data cables)
- Earthing at both ends and coaxial connection of the shield
- Use of filters
- Laying on earthed surfaces

The design of a cable is of decisive importance for the evaluation of EMC. The most commonly employed constructional designs of power and control cables regarding their EMC characteristics are listed in the figure on page 135.

### Selection of EMC cables for applications on cranes and material handling equipment

#### Power cables

In recent years, a new generation of high-speed switching transistors (IGBT) has been employed for converters for variable speed motors. Use of such converters results in high rates of voltage rise and high-frequency harmonics. For this reason consequent interference must be taken into account. In order to counteract this interference, special measures are required for the power cables. We recommend the use of RONDOfLEX (C) shielded EMC cables. As a result of an optimized design regarding shield, materials and geometry, this cable type fulfills all the requirements with respect to mechanical characteristics for flexible cables for festoon system and cable tender operation and is also distinguished by superior shield characteristics. Consequently interference emission is reduced to an acceptable degree or even completely suppressed.

Moreover, the RONDOfLEX (C) cable design helps manufacturers and operators of electrical installations to maintain the limit values specified in the EMC legislation. PROTOLON MV reeling cables and CORDAFLEX (from 35mm<sup>2</sup> conductor cross-section) are also eminently suitable as EMC cables as a result of their precise and symmetrical three-core design.

## Electrical parameters

### Control cables, data transmission and bus cables (e.g. PROFIBUS)

Interference-free data transmission can only be achieved, especially when power and data transmission cables lie close together, by implementation of special measures.

Cable designs with twisted and shielded pairs have proven their suitability for such applications, in particular as bus cables. The laid-up length and the shield are matched so that the transfer impedance and the shield attenuation are optimized at 30 MHz. The following cable designs are eminently suitable for use as data and bus cables:

- CORDAFLEX (SMK) with 3, 6, 9 or 12 twisted and shielded pairs
- CORDAFLEX (SMK) with combined pairs/single cores
- PLANOFLEX with 4 or 6 twisted and shielded pairs
- RONDOFLEX with 6 or 9 twisted and shielded pairs

The table on the next page shows the specific characteristics of crane cables with twisted and shielded pairs ...x(2x1)C as a function of the frequency.

### Cables with fibre-optics

The optimum solution with respect to EMC is the use of glass fibre-optics. In addition to the well-known design OPTOFLEX, we are in a position to offer all the types of cables manufactured by us as combined copper/fibre-optic cables to special order. Prices and delivery times are available on request. In most cases, the overall diameter of the combined cables is identical to that of pure copper cables. Attention is drawn here, in particular, to the PROTOLON design with integrated fibre-optics, which has formed part of our standard delivery program since 1984.

### Standards and regulations relevant to EMC of cables

- IEC 801-3** This standard defines electromagnetic compatibility for instrumentation and control equipment for industrial process applications. It describes methods for evaluation of the susceptibility to electromagnetic interference. It further describes tests, by means of which the influence of electromagnetic interference from external sources on the operational behaviour of cables and their maximum achievable transmission rates can be determined.
- IEC 801-4** Tests based on this standard reveal the maximum loading limits of LAN cables as a result of uniform, random and periodic interference.
- EN 55011 (DIN VDE 0875, Part 11)** In this standard the limit values and measuring procedures for radio frequency interference caused by industrial, scientific and medical high-frequency equipment (ISM devices) are defined.
- EN 55022** This standard corresponds to DIN VDE 0878, Part 3: Limit values and measuring procedures for radio frequency interference caused by information processing equipment (ITE). The radiated energy of a cable can be measured in simulated operation. In addition, the limit value classes A and B for radio frequency interference voltages are defined.
- Official Journal Regulation 243/1991** This regulation of the German Federal Ministry for Post and Telecommunication deals with radio frequency interference voltage emission.

Information on this subject is also to be found in FTZ TL-6145-3000 issued by the Research and Technology Centre of the German Post Office.

### Cable characteristics of crane cables with twisted and shielded pairs ... x(2x1)C

Twisted and shielded pairs (2x1)C can be employed without modification in the different cable designs.





Cable characteristics and frequency dependency		Unit	Frequency in kHz			
			1	10	100	1000
Resistance	R	$\Omega/\text{km}$	38	40	106	314
Inductance	L	$\mu\text{H}/\text{km}$	780	720	606	493
Leakance	G	$\mu\text{S}/\text{km}$	18	128	1305	10770
Capacitance	C	$\text{nF}/\text{km}$	105	102	101	99
Characteristic impedance	Z	$\Omega$	240	97	79	71
Attenuation	$\alpha$	$\text{dB}/\text{km}$	0.9	2	6.3	22.6



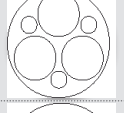
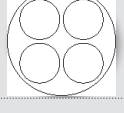

# Crane cables

## Electrical parameters

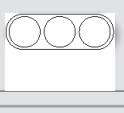
### EMC power cables

Construction	Shield	EMC evaluation
 Symmetrical 3 + 3	Cu braid (possibly with Cu fleece)	Optimum
 Symmetrical 3-core	Cu braid (single core)	Good
 Unsymmetrical 4-core	Cu braid (possibly with Cu fleece)	Good
 Symmetrical 3 + 3	-	Satisfactory
 Unsymmetrical 4-core	-	Mediocre
 Unsymmetrical parallel cores or flat cable	Cu braid	Mediocre
 Unsymmetrical parallel cores or flat cable	-	Poor

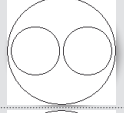
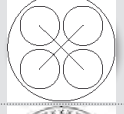
### EMC control cables

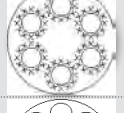
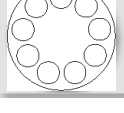
 Symmetrical 2-core	Cu braid (possibly with Cu fleece)	Optimum
 Symmetrical 2-core	-	Very good
 Symmetrical 4-core	-	Good (with symmetrical operation)
 Unsymmetrical concentrically stranded	Cu braid overall shield	Often adequate (with adjacent cores)
 Unsymmetrical concentrically stranded	Cu braid individually shielded cores	Often adequate (with adjacent cores)
 Unsymmetrical concentrically stranded	-	Poor

## Thermal parameters

The different temperature limits of the individual flexible electric cables for cranes and material handling equipment are summarized in the table below.

Under no circumstances may the values shown be exceeded due to interaction of internal Joule heat and the ambient temperature.

If cables are exposed to radiation, e.g. sunlight, the temperature of the outer sheath of the flexible electric cable can rise to a level which is significantly higher than the ambient temperature. This situation must be compensated for by corresponding reduction of the current-carrying capacity.

The temperatures on the surface of the cable are limits for the ambient temperature.

All insulating and sheathing compounds of the flexible electric cables become stiffer as the temperature drops. If the temperature falls below the specified limit, a point can be reached below which the compounds used become brittle.

In addition to this, more force (sometimes considerably more) is needed for bending a flexible electric cable due to the increase of stiffness of the insulating and sheathing compounds at lower temperatures. This can create problems in the use of the flexible electric cables (e.g. with the reel drive).

Flexible cables	Type	Temperature limit during operation, storage, installation and transport (°C)			
		of the conductor during operation	of the conductor during short-circuit	on the surface of the cable, fixed installation	on the surface of the cable, fully flexible installation
CORDAFLEX(SMK)	(N)SHTÖU	90	250	-50 to +80	-35 to +80
EASYFLEX	(N)7YRDGÖU	90	250	-50 to +80	-35 to +80
TROMMELFLEX PUR-HF	D12Y11YU11Y	90	250	-50 to +80	-40 to +80
TROMMELFLEX (K)	NSHTÖU	90	250	-40 to +80	-25 to +80
TROMMELFLEX KSM-S	(N)SHTÖU	90	250	-40 to +80	-40 to +80
CORDAFLEX(SMK)-V	(N)SHTÖU	90	250	-50 to +80	-35 to +80
SPREADER REEL PUR-HF	D12YST11YU11Y	90	250	-50 to +80	-40 to +80
SPREADERFLEX	3GSLTÖ	90	250	-50 to +80	-40 to +80
RONDOFLEX	(N)GRDGÖU	90	250	-50 to +80	-35 to +80
RONDOFLEX(C)-FC	(N)GRDGGÖU	90	250	-50 to +80	-35 to +80
RONDOFLEX(CHAIN)	(N)GRDGÖU	90	250	-50 to +80	-35 to +80
FESTOONFLEX PUR-HF	D12Y11Y	90	250	-50 to +80	-40 to +80
PLANOFLEX	NGFLGÖU	90	250	-50 to +80	-35 to +80
M(Std)HÖU	M(Std)HÖU	90	250	-40 to +80	-30 to +80
OPTOFLEX		-	-	-40 to +80	-35 to +80
PROTOLON(SMK)	(N)TSCGEWÖU	90	250	-50 to +80	-35 to +80
PROTOLON(SMK) LWL	(N)TSKCGEWÖU	90	250	-50 to +80	-35 to +80
TENAX TTS/LWL	(N)TSCGEWÖU	90	250	-40 to +80	-25 to +80
PROTOLON (FL)/LWL	(N)TSFLCGEWÖU	90	250	-50 to +80	-35 to +80

# Crane cables

## Thermal parameters

The relationship between the bending stiffness of flexible electric cables for cranes and material handling equipment and the temperature is shown in the figure below.

The ratio of the bending force is given as  $F/F_0$ , with  $F_0 = F_{20^\circ\text{C}}$ .

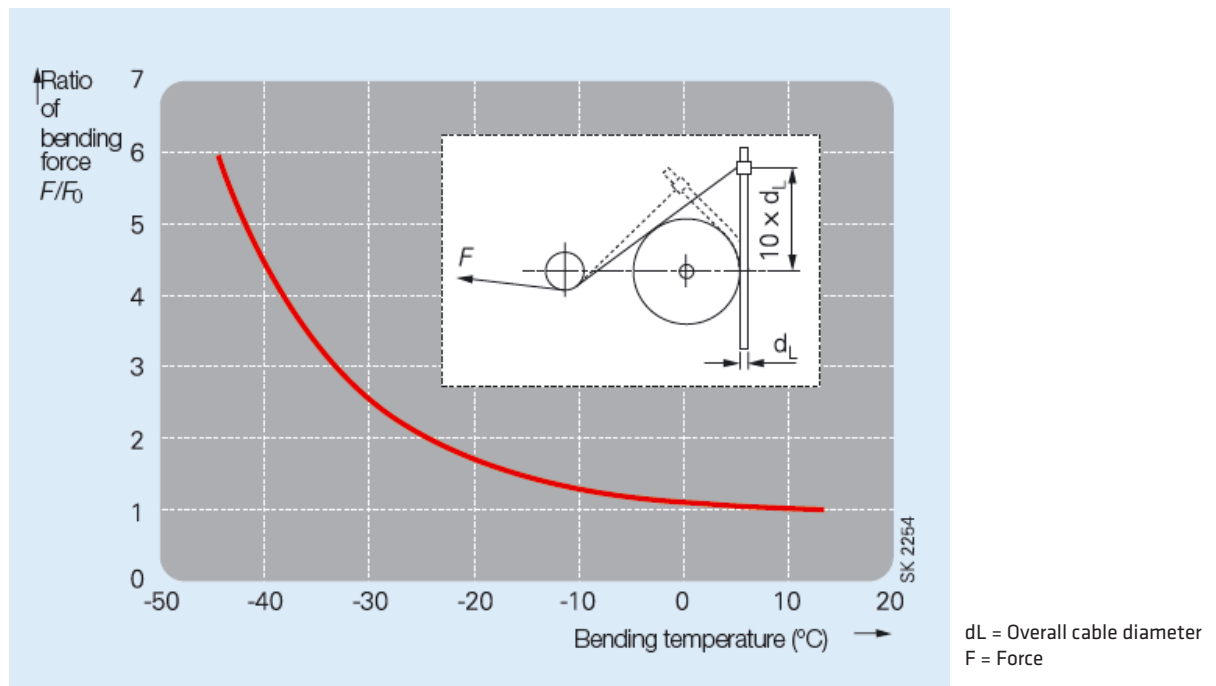

The temperature limits on the surface of the cable are specified to ensure problem-free and healthy operation during forced guidance of flexible electric cables or cranes and material handling equipment, especially while trailing over ground and during reeling operation.

Higher temperatures influence the hardness, abrasion, resistance to tear propagation and the transverse pressure stability of the insulating and sheathing compounds and can thus lead to a reduction of their service life.

Flexible electric cables should be selected, installed and operated so that the expected dissipation of Joule heat is not hindered in any way and therefore no risk of fire is incurred.

## Mechanical parameters

### Tensile loads

The tensile loads of copper conductors in flexible electric cables for cranes and material handling equipment as specified by DIN VDE 0298, Part 3, should not exceed 15 N/mm<sup>2</sup>. However, higher values are allowed for some cables as shown in the table below. These values refer to tensile load only.

These maximum permissible limits of tensile load are to be regarded as the sum of the static and dynamic loads.

When the permissible tensile force is being calculated, shields, concentric conductors and split protective-earth conductors as well as integrated control cores and monitoring cores of power cables must not be included in the calculation.

For higher tensile loads, appropriate steps have to be taken such as increasing the bending radii or using special cable designs with stress relieving support elements. In some cases, a shorter service life can be expected. In this case, the cable manufacturer should be consulted.

The maximum permissible tensile load for installing fixed laying flexible cables is 50 N/mm<sup>2</sup> referred to the cross-section of the conductor.

### Maximum tensile loads during installation and operation of flexible electric cables for cranes and material handling equipment

Flexible cables	Type	DIN VDE N/mm <sup>2</sup>	Prysmian N/mm <sup>2</sup>
CORDAFLEX (SMK)	(N)SHTÖU	15	30
EASYFLEX	(N)7YRDGÖÜ	-	15
TROMMELFLEX PUR-HF	D12Y11YU11Y	-	25
TROMMELFLEX KSM-S	(N)SHTÖU	15	20
TROMMELFLEX (K)	NSHTÖU	15	15
CORDAFLEX (SMK)-V	(N)SHTÖU	15	Increased through additional support element
SPREADER REEL PUR-HF	D12YST11YU11Y	-	Increased through additional support element
SPREADERFLEX	3GSLTÖ	15	Increased through additional support element
RONDOFLEX	(N)GRDGÖÜ	15	15
RONDOFLEX(C)-FC	(N)GRDGCGÖÜ	15	15
RONDOFLEX(CHAIN)	(N)GRDGÖÜ	15	15
FESTOONFLEX PUR-HF	D12Y11Y	-	15
FESTOONFLEX C-PUR-HF	D12YC11Y	-	15
PLANOFLEX	NGFLGÖÜ	15	15
M(Std)HÖU	M(Std)HÖU	15	15
OPTOFLEX		-	500 N for the complete cable
PROTOLON (SMK)	(N)TSCGEWÖÜ	15	20
PROTOLON (SMK) LWL	(N)TSKCGEWÖÜ	15	20
TENAX TTS/LWL	(N)TSCGEWÖÜ	15	20
PROTOLON (FL)/LWL	(N)TSFLCGEWÖÜ	15	15

# Crane cables

## Mechanical parameters

### Torsional stresses

Flexible electric cables for cranes and material handling equipment are generally not designed for torsional stresses. The latter can, however, not be avoided during operation.

The maximum permissible torsional stresses which occur during operation at entries, slewing gears, etc., are summarized in the table below. If the limits are exceeded, this can lead to a reduced lifetime. In critical cases, the cable manufacturer should be consulted.

Torsional stresses created by the systems involved (e.g. due to misalignment of cable guidance systems, oblique cable pay out) should be avoided and are not included here.

### Maximum torsional stresses during operation of flexible electric cables for cranes and material handling equipment

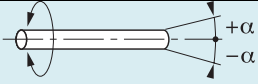
Flexible cables	Type	$\alpha$ (°/m) 
CORDAFLEX (SMK)	(N)SHTÖU	± 50
EASYFLEX	(N)7YRDGÖU	± 15
TROMMELFLEX PUR-HF	D12Y11YU11Y	± 50
TROMMELFLEX KSM-S	(N)SHTÖU	± 50
TROMMELFLEX (K)	NSHTÖU	± 50
CORDAFLEX (SMK)-V	(N)SHTÖU	± 50
SPREADER REEL PUR-HF	D12YST11YU11Y	± 50
SPREADERFLEX	3GSLTÖ	Corresponding to application, designed for best torsional properties
RONDOFLEX	(N)GRDGÖU	± 25
RONDOFLEX(C)-FC	(N)GRDGCGÖU	Not allowed
RONDOFLEX(CHAIN)	(N)GRDGÖU	Not allowed
FESTOONFLEX PUR-HF	D12Y11Y	± 25
FESTOONFLEX C-PUR-HF	D12YC11Y	Not allowed
PLANOFLEX	NGFLGÖU	Not allowed
M(StD)HÖU	M(StD)HÖU	Not allowed
OPTOFLEX		± 50
PROTOLON (SMK)	(N)TSCGEWÖU	± 25
PROTOLON (SMK) LWL	(N)TSKCGEWÖU	± 25
TENAX TTS/LWL	(N)TSCGEWÖU	± 50
PROTOLON (FL)/LWL	(N)TSFLCGEWÖU	Not allowed

## Minimum bending radii

If the bending radii are smaller than those permitted, a reduced service life can be expected depending on the stress conditions. The values given in the table below should be taken as a basis.

The minimum bending radii are shown as the product of the overall diameter of the cable (d) and a numerical factor, which is dependent on the diameter of the cable (e.g.: 3 x d).

The minimum permissible bending radii are valid within the specified ambient temperature range, subject to the provision that the permissible tensile loads are not exceeded.

In critical cases, the cable manufacturer should be consulted.

### Minimum permissible bending radii R

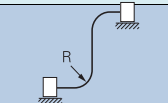
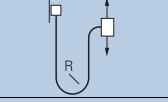
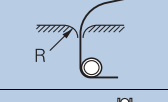
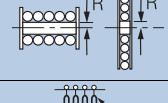
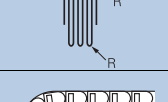
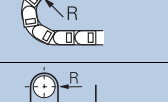
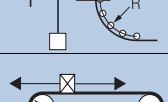
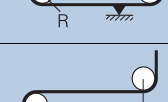
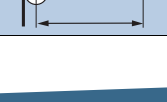
Flexible cables		CORDAFLEX, EASYFLEX, TROMMELFLEX, SPREADER REEL, SPREADERFLEX, RONDOFLEX, FESTOONFLEX, PLANOFLEX, M(Std)HÖU				PROTOLON (*), TENAX	OPTOFLEX
Rated voltage U <sub>0</sub> /U		Up to 0.6/1 kV				Above 0.6/1 kV	minimum permissible bending radius mm
Maximum overall diameter of the cable or maximum height of the flat cable (mm)		Up to 8	Above 8 to 12	Above 12 to 20	Above 20		
	Fixed installation	3 x d	3 x d	4 x d	4 x d	6 x d	125
	Fully flexible operation	3 x d	4 x d	5 x d	5 x d	10 x d	125
	For the entry, e.g. at a centre feed point	3 x d	4 x d	5 x d	5 x d	10 x d	250
	For forced guidance with reeling operation	5 x d	5 x d	5 x d	6 x d	12 x d	250
	For forced guidance with festoon operation	3 x d	4 x d	5 x d	5 x d	10 x d	125
	For forced guidance with power tracks	4 x d	4 x d	5 x d	5 x d	10 x d	125
	For forced guidance with sheaves	7,5 x d	7,5 x d	7,5 x d	7,5 x d	15 x d	250
	For forced guidance with cable tenders	7,5 x d	7,5 x d	7,5 x d	7,5 x d	15 x d	250
	Minimum distance with double or S-type directional changes	20 x d	20 x d	20 x d	20 x d	20 x d	50 x d

(\*) For PROTOLON(FL) it is recommended to consider  $d = 1,5 \times$  maximum height of flat cable

# Crane cables

## Mechanical parameters

### Travel speeds

Flexible electric cables for cranes and material handling equipment are intended for use on mobile equipment and are designed to cope with the technical requirements of the application.

In order to collect, pay out and move flexible electric cables, there are different cable guidance systems such as reels, festoons, tenders, power tracks, baskets, sheave guided cable storage systems and lifts as well as sheaves and multi-roller guides. The cranes and material handling equipment, and consequently also the cable guidance systems, are operated at different travel speeds and are therefore subjected to stress which can vary from low to very high.

During operation of the mobile equipment, the flexible electric cables are subjected to stress such as tension, transverse pressure, torsion and bending. Thus, the travel speed and the acceleration are to be considered as indirect criteria for the stresses applied to the flexible electric cables.

The maximum permissible travel speeds for the individual flexible electric cables are summarized in the table below.

In the case of gantry crane drives, the travel speed of the actual mobile equipment is implied. Usually, cylindrical or mono-spiral reels are employed. The trolley drive carries out horizontal movement of the hoisting gear and the driver's cabin. Festoons, tenders and power tracks or sheave guided cable storage systems are used here as cable guidance systems. In the case of the hoisting gear, the speed of the load-lifting device, such as the spreader or grab, is implied. Normally, either reels located in the trolley or baskets on the load-lifting device are used for the cable guidance system.

If the travel-speed limits are exceeded, a reduction in service life cannot be excluded. The cable manufacturer should be consulted.

### Maximum travel speed for flexible electric cables for cranes and material handling equipment

Flexible cables	Type	Gantry crane drive (reeling)	Trolley drive (festoons and tenders)	Hoist drive (vertical run reeling or basket)
		m/min	m/min	m/min
CORDAFLEX (SMK)	(N)SHTÖU	240	240	160
EASYFLEX	(N)7YRDGÖU	80	no application	no application
TROMMELFLEX PUR-HF	D12Y11YU11Y	180	180	120
TROMMELFLEX KSM-S	(N)SHTÖU	180	180	no application
TROMMELFLEX (K)	NSHTÖU	120	120	no application
CORDAFLEX (SMK)-V	(N)SHTÖU	no application	no application	240
SPREADER REEL PUR-HF	D12YST11YU11Y	no application	no application	180
SPREADERFLEX	3GSLTÖ	no application	no application	160
RONDOfLEX	(N)GRDGÖU	60	240	no application
RONDOfLEX(C)-FC	(N)GRDGCGÖU	60	240	no application
RONDOfLEX(CHAIN)	(N)GRDGÖU	no application	240	no application
FESTOONFLEX PUR-HF	D12Y11Y	no application	210	no application
FESTOONFLEX C-PUR-HF	D12YC11Y	no application	210	no application
PLANOfLEX	NGFLGÖU	no application	180	no application
M(Std)HÖU	M(Std)HÖU	no application	180	no application
OPTOfLEX		120. No random wound reel	240	no application
PROTOLOn (SMK)	(N)TSCGEWÖU	240	120	no application
PROTOLOn (SMK) LWL	(N)TSKCGEWÖU	240	120	no application
TENAX TTS/LWL	(N)TSCGEWÖU	180	60	no application
PROTOLOn (FL)/LWL	(N)TSFLCGEWÖU	120	no application	no application

### Additional tests

Adequate testing of the good operating characteristics needed for flexible electric cables for cranes and material handling equipment is not possible with the tests specified by DIN VDE. Our flexible electric cables for cranes and material handling equipment are therefore subjected to additional and continuous mechanical tests at the manufacturer's works.

These additional tests facilitate time-compressed examination of the running and service characteristics under different kinds of mechanical stress, such as reserved bending strength, running over sheaves, flexing work and reeling operation in relation to tensile load and bending radii.

The additional tests can be seen below and on the next two pages.

### Schematic representation of the additional tests

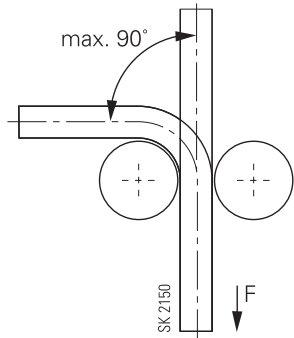
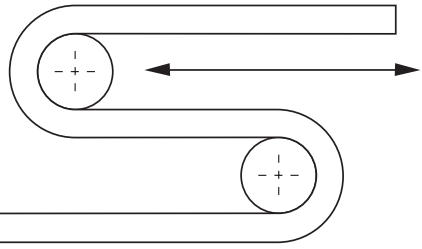
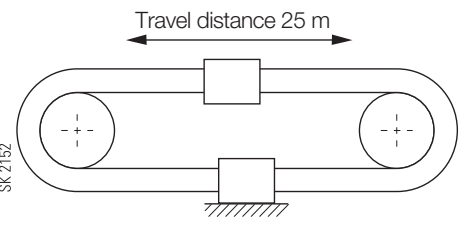
<p><b>Reversed bending test</b></p> <p>Based on DIN VDE 0281, Part 2</p> <p>Testing of flexible electric cables for cranes and material handling equipment under increased loads.</p> <p>Cable diameter up to 50 mm, maximum tensile load 3000 N.</p> <p>Each movement from one extreme position to another (180°) is counted as a cycle.</p>	
<p><b>Roller bending test type A</b></p> <p>Testing the roller bending characteristics of flexible electric cables for cranes and material handling equipment based on DIN VDE 0282, Part 2.</p> <p>Cable diameter up to 50 mm.</p> <p>Each movement between the extreme position is counted as a cycle.</p>	
<p><b>Roller bending test type B</b></p> <p>(Tender test)</p> <p>Practice-oriented testing of flexible electric cables for cranes and material handling equipment with reference to running and service characteristics.</p> <p>Cable diameter from 20 up to 60 mm.</p> <p>Each movement between the extreme position is counted as a cycle.</p>	



# Crane cables

## Mechanical parameters

### Schematic representation of the additional tests

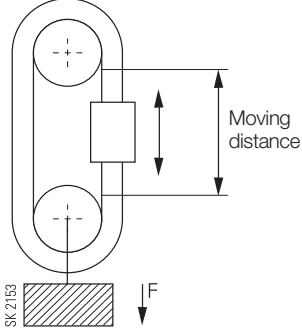
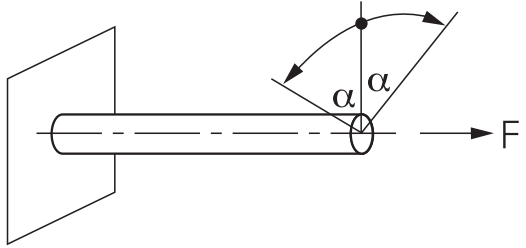
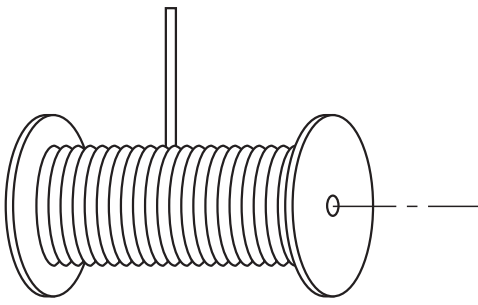
<p><b>Roller bending test type C</b> (Flexing test)</p> <p>Testing the running characteristics (flexing) of flexible electric cables for cranes and material handling equipment for evaluation of the mechanical service characteristics.</p> <p>Cable diameter from 60 up to 120 mm.</p> <p>Each movement between the extreme position is counted as a cycle. Moving distance 2 m.</p>	
<p><b>Torsional stress test</b></p> <p>The cable is alternately twisted left and right through an angle <math>\alpha</math> by application of the tensile force <math>F</math>.</p> <p>Torsional angle max. <math>\pm 360^\circ</math> Torsional torque max. 200 Nm Tensile force max. 4000 N</p>	
<p><b>Reeling test</b></p> <p>Practice-oriented testing of flexible electric cables for cranes and material handling equipment with reference to running and service characteristics.</p> <p>Cable diameter up to 25 mm.</p> <p>Each reeling or unreeling operation is counted as a cycle.</p> <p>The reeled length is 8 m.</p>	

### Additional tests

The following table shows the test conditions for the individual flexible electric cables for cranes and material handling equipment. The tensile loads and the bending and sheave radii are specified and the minimum number of cycles which must be achieved. The decisive criterion for passing a test is the number of individual broken wires in the copper conductor and/or the breaking of the electrical conductor. In the roller bending tests type A and B, the degree of deformation (cork-screwing effect) is tested additionally.

Additional mechanical tests		PROTOLON (SMK)	CORDAFLEX (SMK)	PLANOFLEX		
				Control cable	Power cable	<4mm <sup>2</sup> shielded
Reversed bending test	Tensile load		20 N/mm <sup>2</sup>	5 N/mm <sup>2</sup>		5 N/mm <sup>2</sup>
	Bending diameter		10 x D	DIN VDE 0298, P3 Tab2		10 x D
	Number of cycles		60 000	30 000		30 000
Roller bending test (test type A) D < 50 mm	Tensile load		5 N/mm <sup>2</sup>			
	Bending diameter		10 x D			
	Number of cycles		200 000			
Roller bending test (test type B) 20 mm < D < 60 mm (tender test)	Tensile load		5 N/mm <sup>2</sup>			
	Bending diameter		320 mm			
	Number of cycles		300 000			
Roller bending test (test type C) 60 mm < D < 120 mm (flexing test)	Tensile load	20 N/mm <sup>2</sup>	20 N/mm <sup>2</sup>			
	Bending diameter	10 x D	10 x D			
	Number of cycles	60 000	30 000			

Additional mechanical tests		RONDOFLEX		OPTOFLEX
		Control cable	Power cable	
Reversed bending test	Tensile load	15 N/mm <sup>2</sup>		300 N
	Bending diameter	DIN VDE 0298, P3 Tab2		250 mm
	Number of cycles	60 000	30 000	100 000
Roller bending test (test type A) D < 50 mm	Tensile load			300 N
	Bending diameter			250 mm
	Number of cycles			100 000
Roller bending test (test type B) 20 mm < D < 60 mm (tender test)	Tensile load			
	Bending diameter			40 N
	Number of cycles			200 000
Roller bending test (test type C) 60 mm < D < 120 mm (flexing test)	Tensile load			Reeling test, mono-spiral reeling
	Bending diameter			Reel dia. 250 mm
	Number of cycles			15 000

# Crane cables

## Chemical parameters

### Resistance to chemicals

The individual basic types of materials used for flexible electric cables for cranes and material handling equipment, such as PCP or EPR can be very different from each other in their resistance to chemicals depending on the required properties. Furthermore, the properties of the materials can vary greatly from manufacturer to manufacturer.





Other factors which influence flexible electric cables for cranes and material handling equipment, such as the concentration and degree of wetting of the chemicals, their temperature and the penetration time have different effects on the resistance to chemicals and have to be investigated from case to case.

The chemical industry has drawn up a table which shows a rough summary of the resistance to chemicals of various basic types of material; the overview in the table below is **not** to be deemed a substitute for a detailed examination.

Chemical	Material				
	EPR	PVC	CSM	PCP	PU
Aceton	Resistant	Non-resistant	Limited resistance	Limited resistance	Not tested
Acetic acid, 30 %	Non-resistant	Non-resistant	Limited resistance	Limited resistance	Limited resistance
Aluminium chloride solution	Resistant	Resistant	Resistant	Resistant	Not tested
Aluminium sulfate solution	Resistant	Resistant	Limited resistance	Limited resistance	Not tested
Ammonia, anhydrous	Resistant	Limited resistance	Resistant	Resistant	Not tested
Ammonium chloride solution	Resistant	Resistant	Resistant	Resistant	Not tested
Ammonium hydroxide solution	Resistant	Not tested	Resistant	Resistant	Not tested
Ammonium sulfate solution	Resistant	Resistant	Resistant	Resistant	Not tested
Amyl acetate	Limited resistance	Not tested	Limited resistance	Limited resistance	Not tested
Aniline	Limited resistance	Non-resistant	Non-resistant	Non-resistant	Not tested
Asphalt	Non-resistant	Limited resistance	Limited resistance	Limited resistance	Resistant
Benzene	Non-resistant	Non-resistant	Limited resistance	Resistant	Resistant
Benzole	Non-resistant	Non-resistant	Non-resistant	Non-resistant	Non-resistant
Borax solution	Resistant	Resistant	Resistant	Resistant	Not tested
Boric acid solution	Resistant	Resistant	Resistant	Resistant	Not tested
Butyl acetate	Limited resistance	Non-resistant	Non-resistant	Non-resistant	Not tested
Calcium bisulphite solution	Resistant	Not tested	Limited resistance	Limited resistance	Not tested
Calcium chloride solution	Resistant	Resistant	Resistant	Resistant	Not tested
Calcium hydroxide solution	Resistant	Not tested	Resistant	Resistant	Not tested
Carbon disulphide	Non-resistant	Non-resistant	Non-resistant	Non-resistant	Not tested
Carbon tetrachloride	Non-resistant	Non-resistant	Non-resistant	Non-resistant	Non-resistant
Chlorobenzene	Non-resistant	Non-resistant	Non-resistant	Non-resistant	Not tested
Chloroacetic acid	Limited resistance	Not tested	Limited resistance	Limited resistance	Not tested
Chlorine gas, wet	Limited resistance	Non-resistant	Non-resistant	Limited resistance	Not tested
Chlorine gas, dry	Limited resistance	Non-resistant	Limited resistance	Limited resistance	Not tested
Chloroform	Non-resistant	Non-resistant	Non-resistant	Non-resistant	Not tested
Copper chloride solution	Resistant	Not tested	Resistant	Resistant	Not tested
Copper sulphate solution	Resistant	Not tested	Resistant	Resistant	Not tested
Cyclohexane	Non-resistant	Non-resistant	Limited resistance	Non-resistant	Not tested
Dibutylphthalate	Limited resistance	Non-resistant	Not tested	Non-resistant	Not tested
Diesel oils	Non-resistant	Resistant	Resistant	Resistant	Resistant
Ethyl acetate	Limited resistance	Non-resistant	Non-resistant	Non-resistant	Not tested
Ethyl alcohol	Resistant	Not tested	Not tested	Not tested	Not tested
Ethylene glycol	Resistant	Limited resistance	Resistant	Resistant	Resistant

Resistant
Limited resistance
Non-resistant
Not tested

Chemical	Material				
	EPR	PVC	CSM	PCP	PU
Ethylene oxide	Non-resistant	Not tested	Limited resistance	Non-resistant	Not tested
Formaldehyde, 10 %	Resistant	Not tested	Resistant	Resistant	Not tested
Fuel oil	Non-resistant	Not tested	Limited resistance	Limited resistance	Not tested
Glycerine	Resistant	Not tested	Resistant	Resistant	Not tested
Hydraulic oils	Non-resistant	Limited resistance	Resistant	Resistant	Resistant
Hydrochloric acid, 20 %	Resistant	Resistant	Resistant	Limited resistance	Non-resistant
Hydrogen sulphide	Resistant	Resistant	Resistant	Limited resistance	Not tested
Kerosine	Non-resistant	Limited resistance	Non-resistant	Non-resistant	Not tested
Lactic acid	Resistant	Not tested	Resistant	Limited resistance	Not tested
Linseed oil	Non-resistant	Not tested	Limited resistance	Limited resistance	Not tested
Lubricating oils	Non-resistant	Resistant	Limited resistance	Limited resistance	Not tested
Magnesium chloride solution	Resistant	Resistant	Resistant	Resistant	Not tested
Methanol	Resistant	Resistant	Resistant	Resistant	Resistant
Methyl chloride	Non-resistant	Non-resistant	Non-resistant	Non-resistant	Not tested
Methyl ethyl ketone	Resistant	Non-resistant	Limited resistance	Limited resistance	Not tested
Methyl alcohol	Resistant	Limited resistance	Resistant	Resistant	Non-resistant
Mineral oil	Non-resistant	Non-resistant	Limited resistance	Limited resistance	Not tested
Naphta	Non-resistant	Not tested	Non-resistant	Limited resistance	Not tested
Naphtalene	Non-resistant	Non-resistant	Non-resistant	Limited resistance	Not tested
Nitric acid, 10 %	Resistant	Resistant	Limited resistance	Limited resistance	Not tested
Perchlor ethylene	Non-resistant	Non-resistant	Non-resistant	Non-resistant	Not tested
Petroleum	Non-resistant	Non-resistant	Limited resistance	Limited resistance	Resistant
Phenol	Non-resistant	Non-resistant	Non-resistant	Non-resistant	Not tested
Phosphoric acid	Resistant	Resistant	Resistant	Resistant	Limited resistance
Picric acid	Resistant	Resistant	Resistant	Resistant	Non-resistant
Potassium chloride	Resistant	Resistant	Resistant	Resistant	Resistant
Pyridine	Non-resistant	Non-resistant	Non-resistant	Non-resistant	Not tested
Soap solution	Resistant	Resistant	Resistant	Resistant	Not tested
Sodium hydroxide, 25 %	Resistant	Limited resistance	Resistant	Resistant	Non-resistant
Sodium hypochloride	Resistant	Not tested	Resistant	Limited resistance	Not tested
Soya bean oil	Non-resistant	Non-resistant	Limited resistance	Limited resistance	Not tested
Sulphur	Resistant	Resistant	Resistant	Resistant	Limited resistance
Sulphurous acid	Resistant	Resistant	Resistant	Limited resistance	Not tested
Sulphuric acid < 50%	Resistant	Resistant	Resistant	Resistant	Non-resistant
Stearic acid	Resistant	Limited resistance	Resistant	Resistant	Not tested
Toluene	Non-resistant	Non-resistant	Non-resistant	Non-resistant	Not tested
Transformer oil	Non-resistant	Resistant	Resistant	Resistant	Resistant
Tributyl phosphate	Limited resistance	Not tested	Non-resistant	Limited resistance	Not tested
Trichlorethylene	Non-resistant	Non-resistant	Non-resistant	Non-resistant	Non-resistant
Triethanolamine	Resistant	Not tested	Resistant	Limited resistance	Not tested
Turpentine	Non-resistant	Non-resistant	Non-resistant	Non-resistant	Not tested
Vegetable oils and grease	Limited resistance	Limited resistance	Resistant	Resistant	Resistant
Water	Resistant	Resistant	Resistant	Resistant	Limited resistance
Xylene	Non-resistant	Non-resistant	Non-resistant	Non-resistant	Not tested
Zinc chloride solution	Resistant	Resistant	Resistant	Resistant	Not tested

	Resistant
	Limited resistance
	Non-resistant
	Not tested

# Crane cables

## Conductors

Conductors for flexible electric cables are designed according to DIN VDE 0295. Nowadays, the conductors are made of copper (Cu). Aluminium and other materials have not found general acceptance. An overview of the common kinds of conductors is shown here:

Abbreviation	Designation	Specification/regulation
RE conductor	Circular, solid	DIN VDE 0295 Class 1
RM conductor	Circular, stranded	DIN VDE 0295 Class 2
RMV conductor	Circular, stranded, compacted	DIN VDE 0295 Class 2
F conductor	Finley stranded	DIN VDE 0295 Class 5
FS conductor	Very finely stranded	Prysmian specification
FF conductor	Extremely finely stranded	DIN VDE 0295 Class 6

In many countries, the design of the conductors according to DIN VDE 0295 is accepted. The regulation corresponds to CENELEC HD 383.52 and IEC 60228.

The conductor classes F, FS and FF are employed for flexible electric cables for cranes and material handling equipment. The conductor classes are divided into nominal cross-sections. The individual conductor classes F, FS and FF and the nominal cross-sections are defined by specification of the maximum diameter of the single wires and by the maximum resistance of the conductor at 20 °C (see also the table below).

These flexible conductors are made of bare or tinned annealed copper. The conductors are constructed of many single wires, all of which must have the same diameter.

Nominal Cross-section mm <sup>2</sup>	Max. diameter of the single wires mm			Resistance of the conductor at 20 °C Ω/km	
	F conductor (Class 5)	FS conductor (Prysmian)	FF conductor (Class 6)	Bare single wires	Tinned single wires
0.5	0.21	0.16	0.16	39	40.1
0.75	0.21	0.16	0.16	26	26.7
1	0.21	0.16	0.16	19.5	20
1.5	0.26	0.21	0.16	13.3	13.7
2.5	0.26	0.21	0.16	7.98	8.21
4	0.31	0.26	0.16	4.95	5.09
6	0.31	0.26	0.21	3.30	3.39
10	0.41	0.26	0.21	1.91	1.95
16	0.41	0.31	0.21	1.21	1.24
25	0.41	0.31	0.21	0.784	0.795
35	0.41	0.31	0.21	0.554	0.565
50	0.41	0.36	0.31	0.386	0.393
70	0.51	0.36	0.31	0.272	0.277
95	0.51	0.41	0.31	0.206	0.210
120	0.51	0.41	0.31	0.161	0.164
150	0.51	0.41	0.31	0.129	0.132
185	0.51	0.41	0.41	0.106	0.108
240	0.51	0.41	0.41	0.0801	0.0817
300	0.51	0.41	0.41	0.0641	0.0654

Formula for the temperature correction factor for annealed copper conductors (plain or metal coated):

$$k_{t,Cu} = \frac{254,5}{234,5 + t}$$

Where t is the temperature of the conductor in degrees Celsius.

The Resistance values in the table above (R20) shall be divided by the correction factor (kt), in order to obtain the resistance value at temperature different from 20°C

$$R_t = \frac{R_{20}}{k_{t,Cu}}$$

The conductors used in flexible electric cables for cranes and material handling equipment are summarized in the table below.

The conductor for flexible electric cables is designed according to DIN VDE 0295, as described in the table and especially in the table on the left page. The construction of the conductor itself and its design features are open to variation.

Flexible cable	Type	Conductor used
CORDAFLEX (SMK)	(N)SHTÖU	Tinned electrolytic copper, very finely stranded, Class "FS"
EASYFLEX	(N)7YRDGÖU	Bare electrolytic copper, very finely stranded, Class "FS"
TROMMELFLEX PUR-HF	D12Y11YU11Y	Bare electrolytic copper, finely stranded, Class 5
TROMMELFLEX KSM-S	(N)SHTÖU	Bare electrolytic copper, finely stranded, Class 5
TROMMELFLEX (K)	NSHTÖU	Tinned electrolytic copper, finely stranded, Class 5
CORDAFLEX (SMK)-V	(N)SHTÖU	Bare electrolytic copper, very finely stranded, Class "FS"
SPREADER REEL PUR-HF	D12YST11YU11Y	Bare electrolytic copper, finely stranded, Class 5
SPREADERFLEX	3GSLTÖ	Bare electrolytic copper, very finely stranded, Class "FS"
RONDOFLEX	(N)GRDGÖU	Bare electrolytic copper, finely stranded, Class 5
RONDOFLEX(C)-FC	(N)GRDGCÖU	
RONDOFLEX(CHAIN)	(N)GRDGÖU	
FESTOONFLEX PUR-HF	D12Y11Y	Bare electrolytic copper, finely stranded, Class 5
FESTOONFLEX C-PUR-HF	D12YC11Y	
PLANOFLEX	NGFLGÖU	Bare electrolytic copper: up to 25 mm <sup>2</sup> extremely finely stranded, Class 6; from 35 mm <sup>2</sup> finely stranded, Class 5
M(StD)HÖU	M(StD)HÖU	Bare electrolytic copper: up to 25 mm <sup>2</sup> extremely finely stranded, Class 6; from 35 mm <sup>2</sup> finely stranded, Class 5
OPTOFLEX		Fibre-optics, no copper conductors
PROTOLON (SMK)	(N)TSCGEWÖU	Tinned electrolytic copper, very finely stranded, Class "FS" (protective-earth conductor, likewise)
PROTOLON (SMK) LWL	(N)TSKCGEWÖU	
TENAX TTS/LWL	(N)TSCGEWÖU	Bare electrolytic copper, finely stranded, Class 5
PROTOLON (FL)/LWL	(N)TSFLCGEWÖU	Tinned electrolytic copper, finely stranded, Class 5 (protective-earth conductor, likewise)

# Crane cables

## Conductors

The figure shows the design elements of a conductor for flexible electric cables for cranes and material handling equipment. Depending on the cross-section of the conductor, a flexible conductor consists of one or more strands which are laid up around a central strand in several layers. In the diagram, six individual strands (second layer) are laid up around a central strand (first layer). A third layer would then be made from  $6 + 6 = 12$  individual strands, arranged around the second layer.

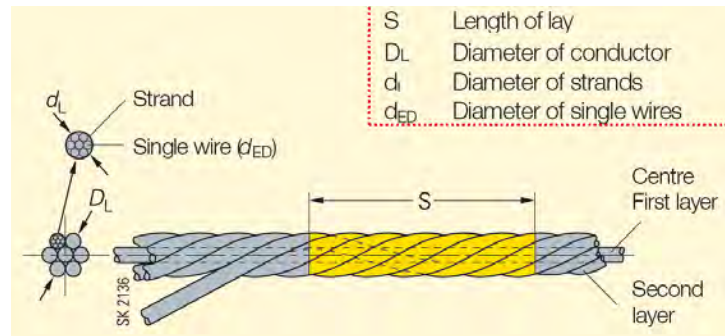

The strands of the flexible conductors consist of many single wires bunched together. The single wires can be laid up (bunched) to the right or left, thus determining the direction of lay. This is shown in the figure as the Z direction of lay (right) or the S direction of lay (left).

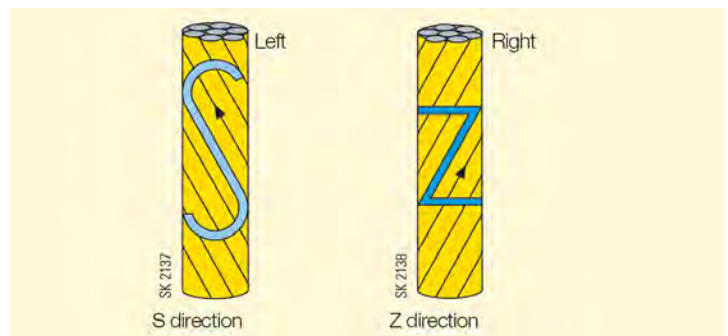

This also applies to a conductor which is laid up of single strands.

The conductor design and the nominal cross-section of the flexible F, FS and FF conductors for flexible electric cables are usually as shows in the table.

Conductor design		
	Bunched	Stranded
F conductor	up to 10 mm <sup>2</sup>	from 16 mm <sup>2</sup>
FS conductor	up to 2.5 mm <sup>2</sup>	from 4 mm <sup>2</sup>
FF conductor	up to 2.5 mm <sup>2</sup>	from 4 mm <sup>2</sup>

Depending on the combination of the individual design elements of a conductor, there are three basic types of conductors (see table):

The main advantage of the **uniform-lay conductor** is its high flexibility. As a result of its design, the conductor also has a smaller diameter than other types of conductors. Disadvantages are its susceptibility to torsional loads (unstable) and its poor resistance to axial compression and sharp bending. The uniform-lay conductor is used for all TROMMELFLEX, FESTOONFLEX and TENAX cables.

The **alternating-lay conductor** is very stable with respect to torsional loads and is not sensitive to axial compression and sharp bending. A disadvantage is its relatively low flexibility. As a result of its design the many crossing points of the single wires cause a lot of friction, which can lead to early breaking of the conductor, as compared to the other two types of conductors. The alternating-lay conductor has the largest diameter compared to the other two types of conductors.

The design of the **opposite-lay conductor** best meets the requirements of flexible electric cables for cranes and material handling equipment. It combines the advantages of both the uniform-lay conductor and the alternating-lay conductor without any of their disadvantages. This conductor is highly flexible, remains stable with respect to torsional loads and exhibits high axial compression and sharp bending strength. It has proven its excellent characteristics in many years of practice. The opposite-lay conductor is used for CORDAFLEX, PLANOFLEX, RONDOFLEX, SPREADERFLEX and PROTOLON.

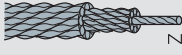
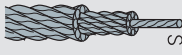
Types of conductor				
Uniform-lay conductor		Design	Strand	Layer
		Centre	Z	
		2 <sup>nd</sup> layer	Z	Z
		3 <sup>rd</sup> layer	Z	Z
Alternating-lay conductor		Design	Strand	Layer
		Centre	Z	
		2 <sup>nd</sup> layer	S	Z
		3 <sup>rd</sup> layer	Z	S
Opposite-lay conductor		Design	Strand	Layer
		Centre	S	
		2 <sup>nd</sup> layer	S	Z
		3 <sup>rd</sup> layer	S	Z



# Crane cables

## Compounds

### Insulating and sheathing compounds

The table below gives an overview of all common compounds used for flexible electric cables. A basic distinction is made between thermoplastics and elastomers:

Thermoplastics, generally known as plastic, are usually **not cross-linked**

Elastomers, generally known as rubber, are always **cross-linked**

Serial No.	Material	Abbreviation	Type designation	
			VDE	Harm.
<b>Thermoplastics</b>				
1	Polyvinyl chloride	PVC	Y	V
2	Cross-linked polyvinyl chloride	PVC	X	V4
3	Polyethylene	PE	2Y	E
4	Cross-linked polyethylene	XLPE	2X	X
5	Low-pressure polyethylene	PE	2Yn	E2
6	Foam polyethylene	PE	02Y	
7	Polystyrene	PS	3Y	Q3
8	Polyamide	PA	4Y	Q4
9	Polytetrafluor ethylene	PTFE	5Y	E4
10	Perfluor ethylene propylene	PEP	6Y	E5
11	Ethylene tetrafluor ethylene	ETFE	7Y	E6
12	Polyimide	PI	8Y	Q5
13	Polypropylene	PP	9Y	E7
14	Polyvinylidene fluoride	PVDF	10Y	Q6
15	Polyurethane	TPU/PU	11Y	Q
16	Polyterephthalic acid ester	PETP	12Y	Q2
17	Polyester thermoplastic		13Y	
18	Perfluor ethylene oxyalkane	PFA	14Y	
19	Polychlorotrifluor ethylene	ECTFE	15Y	
<b>Elastomers</b>				
20	Natural rubber	NR	G	R
21	Synthetic rubber	SR	G	R
22	Styrene-butadiene rubber	SBR	G	R
23	Silicon rubber	SIR	2G	S
24	Isobutylene-isoprene rubber	IIR	3G	B3
25	Ethylene-propylene rubber	EPR/EPDM	3G	B
26	Ethylene vinylacetate	EVA	4G	G
27	Chloroprene rubber	CR/PCP	5G	N
28	Chlorosulfonated polyethylene	CSM	6G	N4
29	(Hypalon)			
30	Fluor elastomers		7G	
31	Nitrile butadiene rubber	NBR	8G	N5
32	Chlorated polyethylene	CM/CPE		

#### Notes

Y: Type designation for a thermoplastic material

G: Type designation for an elastomeric material

X: Type designation for a cross-linked thermoplastic material (the letter „X“ replaces the „Y“ in „2X“ for cross-linked polyethylene)

0: Additional designation for foam materials (the zero is placed in front of the relevant type designation, e.g. „02Y“ for foamed PE)

The insulating and sheathing compounds, which are employed in flexible electric cables for cranes and material handling equipment constructed according to the existing VDE standards listed below, are compared with respect to the individual requirements in the table below. The characteristics are specified in DIN VDE 0207 or EN 50290 and allow a preliminary estimation of the properties of these compounds.

Requirements		Unit	Compound			
			Sheath	Sheath	Sheath	Insulation
			CR/CM	CR/CM	SR	EPR
			5GM3	5GM5	GM1b	3GI3
Max. permissible operating temperature at the conductor		°C	90	90	90	90
Tensile strength before ageing	min.	N/mm <sup>2</sup>	10.0	15.0	4.2	4.2
Elongation at break before ageing	min.	%	300	300	200	200
Ageing	at	°C	100 ±2	100 ±2	100 ±2	135 ±2
	over	d	7.0	7.0	7.0	7.0
Change in tensile strength after ageing	max.	%	±30	±30	-	±30
Elongation at break after ageing	min.	%	250	250	200	-
Change in elongation at break after ageing	max.	%	±40	±40	-	±30
Abrasion	max.	mm <sup>3</sup>	-	300	-	-
Resistance to tear propagation	min.	N/mm	-	30	-	-
Thermal expansion	at	°C	100 ±2	100 ±2	-	200 ±3
	over	min.	15	15	15	15
	with	N/cm <sup>2</sup>	20	20	20	20
	loaded max.	%	175	175	175	175
	relieved max.	%	25	25	25	25
Resistance to oil (ASTM Oil No. 2)	at	°C	100 ±2	100 ±2	-	127 ±1
	over	h	24	24	-	40
	with	bar	-	-	-	5.5 ±0.2
Change in tensile strength	max.	N/mm <sup>2</sup>	±40	±40	-	±30
Change in elongation at break	max.	%	±40	±40	-	±30
Surface resistance at 20°C	min.	Ω				-
Volume resistance at 20°C	min.	Ω x cm	-	-	-	

## Shield

The shield is a „barrier“ against electromagnetic fields and protects electric signals against external interference. The aim is to weaken or stop unwanted signals to such an extent that the wanted data signals can be transmitted without interference in the endangered signalling conductor. There are three basic types of shield structure:

- Overall shield over several cores
- Shielded pairs
- Individually shielded cores.

An overall sheath over several cores, which as a rule is situated between the inner and outer sheath of a cable, has not found general acceptance for reeling cables, because as a result of frequent bending the tensile and pressure forces within the cable lead to premature destruction of the shields and to failure of the cable.

Shielded pairs and individually shielded cores, on the other hand, have proven themselves in practice and are successfully used in Prysmian Group cables.

Braided screens are characterized by their transfer impedance which is defined as the ratio of the voltage drop along the shield on the interfered side to the parasitic current on the other side. The transfer impedance  $R_k$  (DIN 40500) is given for a specific frequency in  $m\Omega/m$  and is usually plotted with respect to frequency. The lower the transfer impedance of a shield, the better the screening effect. The transfer impedance of the braided screens usually used for flexible electric cables for mining applications is optimized at 30 MHz and is therefore focussed on data-processing quality.

A typical transfer impedance characteristic is shown in the diagram.

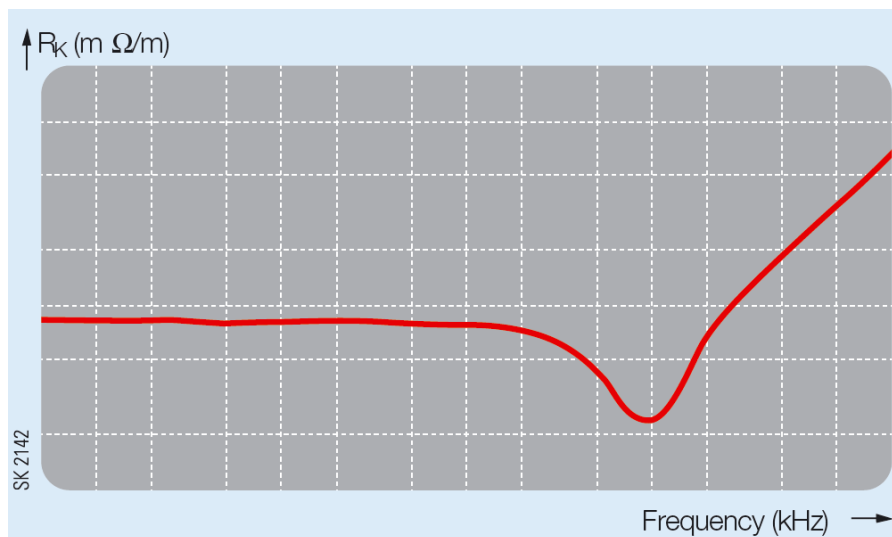

## Electrical field control with cables

The cores of MV-reeling and trailing cables of voltage level 6 kV and above are always equipped with inner and outer semiconductive layers made of semiconductive rubber.

The inner and outer semiconductive layers are extruded with the insulation in a single-pass operation. Secure bonding to the insulation is obtained as a result of this method of extrusion.

The inner semiconductive layer prevents build-up of excessive electrical field strength at the individual wires of the flexible conductor and partial discharges between the conductor and the insulation.

The outer semiconductive layer serves as a core shield and performs the following tasks:

- Protection against electric shock
- Avoidance of partial discharges in the conductor assembly
- Generation of the radial electrical field in the insulation
- Discharge of current in the event of a fault.

The core shield is thus an integral component of the protective-earth conductor.

The resistance between the protective-earth conductor and any point on the outer semiconductive layer must not exceed 500  $\Omega$ . The protective-earth conductor, which touches the core shield, is covered with semiconductive rubber and ensures longitudinal conductivity of the system. The figure below shows the cross-section of a MV-cable with inner and outer semiconductive layers.

In addition to the electrical requirements, the core shield in flexible electric cables for cranes and material handling equipment must also be able to cope with the high (sometimes very high) mechanical stresses.

Metal shields are more liable to become defective when used in flexible electric cables for mining applications and are inferior to shields made of semiconductive rubber material.

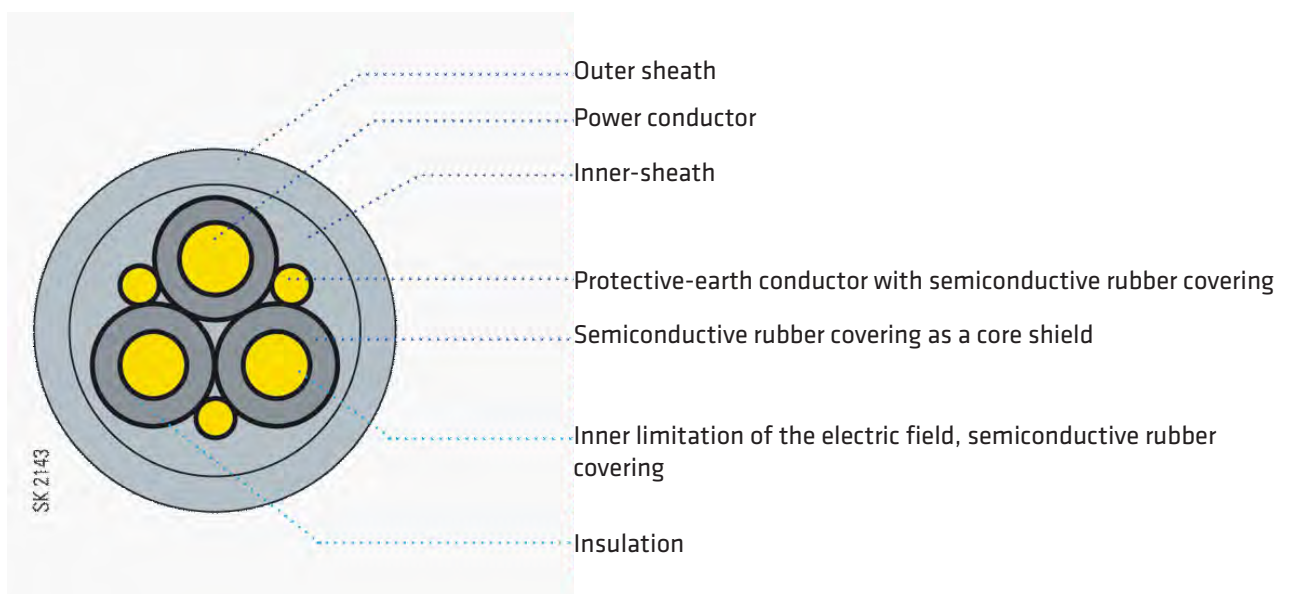

# Crane cables

## Core arrangement

The basic criteria of the core arrangement for flexible electric cables for cranes and material handling equipment are summarized in the table below.

In round flexible electric cables, the individual cores are arranged by laying them up. Up to three cores are laid up without a central element. Four cores and above are laid up around a centre, which can also consist of three-core stranded elements.

A stretched core in the centre of the flexible cable (as the actual centre or placed in the centre) is not permitted according to the DIN VDE standards. A stretched core at the centre of the flexible cable would quickly result in premature failure of the conductor due to breakage, especially in flexible electric cables for cranes and material handling equipment.

A maximum of three core layers is best for the conductor assembly. Investigations have shown that, if there are more than three layers, the internal stability of the flexible cable and in consequence the service life is reduced as a result of increasing secondary and relative forces between the cores.

The length of lay  $S$  is a design feature used for laying up the conductor assembly (see table) and influences the bending flexibility and the bending stability. The length of lay is an important factor for the service life of flexible electric cables for cranes and material handling equipment.

### Round flexible cables

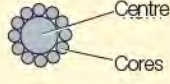
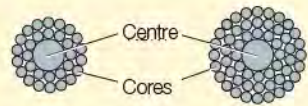
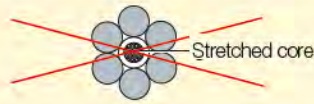
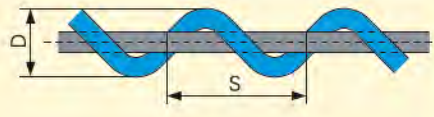
 <p>2x      3x      4x</p>	Laying up of two to four cores without a centre
 <p>Centre Cores</p>	Laying up of five or more cores with centre Special design: the centre comprises three cores
 <p>Centre Cores</p>	Maximum three-layer design (standard up to 44 cores)
 <p>Stretched core</p>	A stretched core in the centre of a flexible cable is not permitted
 <p><math>D</math>      <math>S</math></p>	The length of lay $S$ is the length, measured in the direction of the lay, over which a core circumscribes $360^\circ$ around the laying axis. It is given as a multiple of the diameter $D$ over the conductor assembly, e.g. $S = 8 \times D$ .

The table below shows the normal lengths of lay in flexible electric cables for cranes and material handling equipment.

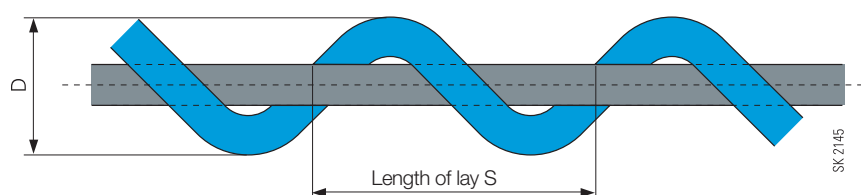

Type of cable	Length of lay for flexible electric cables for cranes and material handling equipment	Flexible cables	
<b>Flexible reeling cables</b>			
(N)SHTÖU	5 x D	CORDAFLEX (SMK)	
(N)7YRDGÖU	6 x D	EASYFLEX	
(N)SHTÖU	8 x D	TROMMELFLEX KSM-S	
D12Y11YU11Y	8 x D	TROMMELFLEX PUR-HF	
NSHTÖU	7 x D	TROMMELFLEX (K)	
D12YST11YU11Y	8 x D	SPREADER REEL PUR-HF	
<b>Flat rubber-sheathed flexible cables</b>			
NGFLGÖU	Parallel arranged cores or bundles	PLANOFLEX	
M(StD)HÖU	Parallel arranged cores or bundles	M(StD)HOEU	
<b>Round rubber-sheathed flexible cables</b>			
(N)GRDGÖU	10 x D	RONDOFLEX	
D12Y11Y	8 x D	FESTOONFLEX PUR-HF	
<b>Special flexible cables for gravity-fed collector basket operation</b>			
3GSLTÖ	Individual cores laid up in bundles	15 x D	SPREADERFLEX
	Bundles laid up around the centre	10 x D	
<b>Rubber-sheathed flexible fibre-optic cables</b>			
	Especially laid-up around a GFK support element		OPTOFLEX
<b>M.V. reeling cables</b>			
(N)TSCGEWÖU	7 x D	PROTOLON (SMK)	
(N)TSCGEWÖU	10 x D	PROTOLON (SMK) LWL	
(N)TSFLCGEWÖU	Parallel arranged cores or bundles	TENAX TTS	
		PROTOLON (FL)	

# Crane cables

In the case of flat flexible cables, laying up is not usually necessary as the cores are arranged parallel to each other. Flat flexible cables with laid up bundles represent an exception to this rule. This special form of core arrangement is selected for large numbers of cores in order to ensure the required stability of flat cables.

## Flat flexible cables

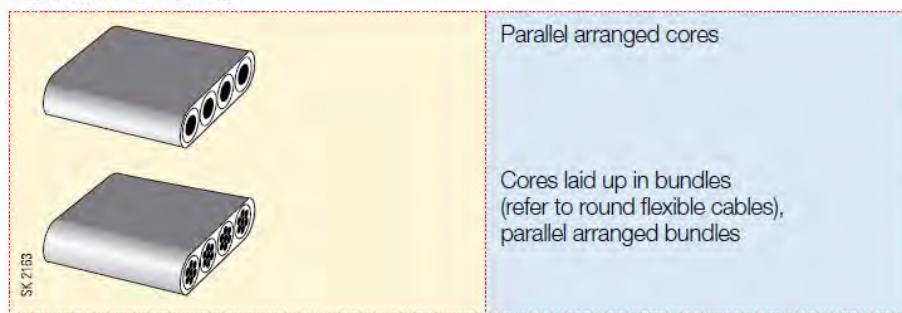

## Colour coding of fibre-optics

Colour Coding for CORDAFLEX, SPREADERFLEX, OPTOFLEX, PROTOLON

	No. of fibres	Fibre colour	Hollow core colours
Monomode design E9/125 $\mu\text{m}$	6 x 1E9/125	OR/BN/WT/RD/BK/YE	6 x NA
	6 x 2E9/125	OR-PK/BN-PK/WT-PK/RD-PK/BK-PK/YE-PK	6 x NA
	6 x 3E9/125	BU/OR/GN	YE/BK/NA/NA/NA/NA
Graded-index fibre design G50/125 $\mu\text{m}$	6 x 1G50/125	OR/GN/BN/WT/RD/BK	6 x NA
	6 x 2G50/125	OR-PK/GN-PK/BN-PK/WT-PK/RD-PK/BK-PK	6 x NA
	6 x 3G50/125	BU/OR/GN	GN/BK/NA/NA/NA/NA
Graded-index fibre design G62.5/125 $\mu\text{m}$	6 x 1G62.5/125	BU/OR/BN/WT/RD/BK	6 x NA
	6 x 2G62.5/125	BU-PK/OR-PK/BN-PK/WT-PK/RD-PK/BK-PK	6 x NA
	6 x 3G62.5/125	BU/OR/GN	BU/BK/NA/NA/NA/NA

Bold-faced colour designations identify the fibre type

Colour Coding for TROMMELFLEX, TENAX

Fibre Optic Types	Hollow core colours (PBT - Tube)
2x Monomode design E9/125 µm	YE/RD
2x Graded-index fibre design 50/125 µm	GN/RD
2x Graded-index fibre design 62.5/125 µm	BU/RD
1x Monomode design E9/125 µm + 1x Graded-index fibre design 50/125 µm	YE/GN
1x Monomode design E9/125 µm + 1x Graded-index fibre design 62.5/125 µm	YE/BU

Number of fibres per hollow core	Colour Coding of Fibres
6	RD/GN/BU/YE/WT/GR
12	RD/GN/BU/YE/NA/GR/BN/VI/TK/BK/WT/OR
18	RD/GN/BU/YE/NA/GR/BN/VI/TK/BK/WT/OR/PK with black marking: RD/GN/BU/YE/NA
24	RD/GN/BU/YE/NA/GR/BN/VI/TK/BK/WT/OR/PK with black marking: RD/GN/BU/YE/NA/GR/VI/TK/WT/OR/PK

Abbreviations for colour coding of the fiber optics:

code	colour
BK	black
BN	brown
BU	blue
CY	cyan
GN	green
NA	nature colour
OR	orange
PK	pink
RD	red
TK	turquoise
VI	violet
WH	white
YE	yellow



## Support elements

Flexible electric cables for cranes and material handling equipment should not be stressed above the limits set out in table „Maximum tensile loads“ for the permissible tensile forces. If higher tensile forces are to be expected, support elements have to be integrated as part of the structure of the cable. There are several possibilities for integration of support elements in cables.

The following two options are normally used:

- As support element located in the centre of the cable or
- As braid between the inner and outer sheath

The force/elongation diagram in the figure shows the characteristic of these cables with different arrangements of support elements as compared to a cable without a support element.

After a compacting phase, in which the individual cable elements are initially pulled together, until the copper conductor begins to bear the tensile force, the cable without a support element remains linear in the first section of the curve (curve C). In the next phase elongation increases considerably on a slight increase of force.

Cables with a braid as a support element between the inner and outer sheath behave in the first section of the curve (curve B) in a similar manner to cables without a support element. The braid becomes effective as a support element and bears the applied force only after the force and the consequent elongation have increased over a certain period of time. The tensile force which is borne increases with less elongation than that of the cable without a support element. The braid as a support element can prevent the cable, e.g. from tearing.

Cables with a central support element behave differently provided that the support element was correctly dimensioned. The support element bears the tensile forces from the very beginning and thus relieves the copper conductor (curve A).

The force/elongation characteristics of the support elements and of the copper conductors are decisive for correct design of the support element and dimensioning of the flexible cables. The actual design should be worked out in close co-operation with the cable manufacturer.

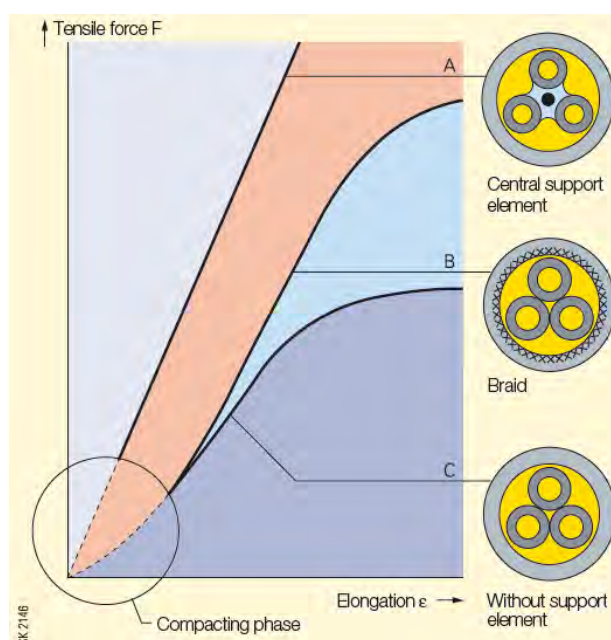

## Anti-torsion braid

Flexible electric cables for cranes and material handling equipment are often fitted with an anti-torsion braid between the inner and outer sheath in order to minimize twisting under torsional loads. This applies to CORDAFLEX, TROMMELFLEX, PROTOLOX and TENAX.

An anti-torsion braid is not used for flat cables (not possible for this particular type of cable), cables for festoon application (not necessary for the application involved) and basket operation (fully designed for best torsional properties).

The effect of an anti-torsion braid on the angle of torsion  $\alpha$  with increasing torsional moment for comparable cables with and without an anti-torsion braid is shown in the figure below. The flexible cable with anti-torsion braid tends to twist less than the flexible cable without a braid for the same torsional moment.

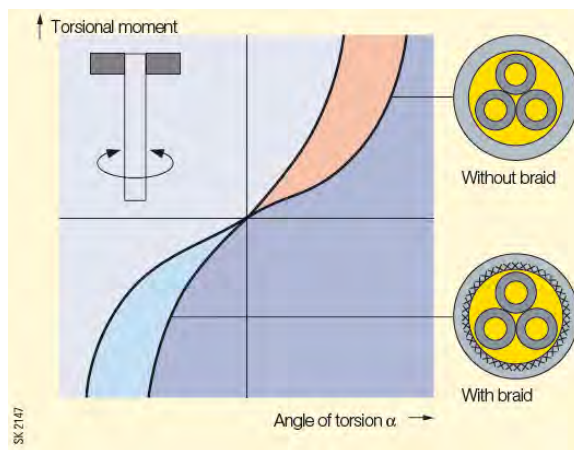

## Cable Drum Overview

Drum size	Weight kg	Dimensions $\varnothing$ x width cm	Volume m <sup>3</sup>
051	9	50 x 46	0.09
071	23	71 x 48	0.19
081	28	80 x 48	0.26
091	43	90 x 64	0.45
101	50	100 x 64	0.70
121	125	125 x 76	1.09
141	145	140 x 95	1.37
161	210	160 x 95	2.01
181	280	180 x 110	2.80
200	380	200 x 110	4.24
220	500	224 x 138	5.44
224	700	240 x 138	7.26
281	900	280 x 138	10.10
300	1100	300 x 170	12.14
320	1200	320 x 170	18.10
340	1400	340 x 220	20.43

# Crane cables

## Comparison

AWG-Size	Equivalent cross-section (mm <sup>2</sup> )	Closest metrical cross-section (mm <sup>2</sup> )
18	0.82	1.0
16	1.31	1.5
14	2.08	2.5
12	3.31	4.0
10	5.26	6.0
8	8.37	10.0
6	13.30	16.0
4	21.15	25.0
2	33.63	35.0
1	42.41	50.0
1/0	53.48	50.0
2/0	67.43	70.0
3/0	85.01	95.0
4/0	107.20	120.0
250 MCM	126.64	150.0
300 MCM	152.00	150.0
350 MCM	177.35	185.0
400 MCM	202.71	240.0
500 MCM	253.35	300.0
600 MCM	303.96	300.0
750 MCM	379.95	400.0
1000 MCM	506.71	500.0

AWG = American Wire Gage





# Linking global expertise to the wheels of industry

**Prysmian Kabel und Systeme GmbH**

Alt Moabit 91D

10559 Berlin, Germany

E-Mail: [kontakt@prysmiangroup.com](mailto:kontakt@prysmiangroup.com)

[www.prysmiangroup.com](http://www.prysmiangroup.com)

[www.prysmiangroup.de](http://www.prysmiangroup.de)

**Prysmian**  
Group

